

reflex

Thinking solutions.

Pressurisation systems



Reflexomat, Variomat



We are only satisfied if you are

Reflex has set itself the goal of supporting you with well thought-out solutions. Whatever job you need doing in water supply engineering, why not put your trust in our comprehensive range of products and accompanying tailored services? We will ensure that your decision to opt for Reflex is the right one in every respect – from advice and design to installation and ongoing operation.



Thinking solutions.

Reflex's mission is embodied in the company's slogan: "Thinking solutions". Reflex's strength is to think in terms of solutions. Reflex develops ideas that help you to move forward based on decades of experience, in-depth technical understanding and intimate knowledge of the industry!

We make sure that everything fits

Heating, cooling and hot water supply systems - the demands on supply equipment are varied and complex. You'll be well-advised for every eventuality with our coordinated product ranges. Reflex can offer you the right components for each specific task – and you can be sure that they can be integrated seamlessly into the interplay of a larger overall solution. The result: well thought-out systems that simply perform better.























In this product guide, we've summarised our entire product range for you meaning you can locate all our available products, series and technical information quickly and easily. All weights given are net weights.

Reflex reserve the right to modify the details published in this document. General Sales Conditions of Reflex Winkelmann GmbH: Please consult www.reflex.de

Contents

Pressurisation Systems

	Reflexomat control unit	6
	Reflexomat system components	7
	Reflexomat working principle	8-9
	Reflexomat technical data	10-13
	Reflexomat options	14
	Reflexomat product application	15
	Reflexomat selection graph	16
	Variomat control unit	18
	Variomat system components	19
	Variomat working principle	20-21
	Variomat technical data	22-23
	Variomat options	24
	Variomat product application	25
	Variomat selection graph	26
	Variomat Giga control unit	28
	Variomat Giga system components	29
	Variomat Giga working principle	30-31
	Variomat Giga technical data	32-33
	Variomat Giga options	34
	Variomat Giga product application	35
	Variomat Giga selection graph	36

Count on us - from the initial idea to the solution

Reflex offer a range of services to assist you in finding the solution that best suits your needs. Take advantage of our combined expertise and experience and develop professional solutions together with us, down to the very last detail.



Made-to-measure design: With the Reflex Pro calculation program

Take the easiest route to correct design and sizing: Reflex Pro is the proven, continuously developed software solution you can use to quickly and simply achieve precise results. The software is available in three versions and we also offer a CAD library of our products for integration into your construction programmes.

Visit www.reflex.de/pro for further information and the option of downloading free of charge.

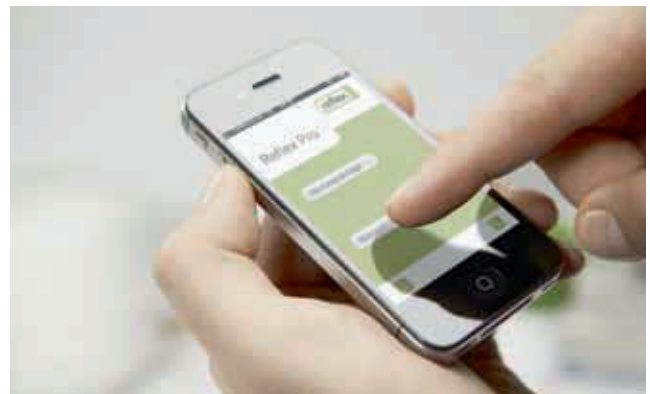

Reflex Pro Web

The online version calculates pressure retention and heat transfer systems in a few simple steps. The results are provided in the form of a PDF or text file for further use.

Reflex Pro App

Reflex Pro is available as an app for Android phone, iPhone, iPad and iPod touch! Whether you need to make a quick calculation on site or design a project on your mobile you will always leave a professional impression with your customers with the Reflex Pro app.

Reflex Pro Win

The full range of services for convenient use even without an Internet connection. The download version for Windows systems is perfect when you are regularly planning and designing pressure retention and heat transfer systems.

Reflexomat

Pressurisation unit compressor-controlled

For Control Touch:



Control Unit

Control Basic

Control Basic S

Control Touch



- 2-line LCD display
- 8 control keys
- 2 status displays
- Integrated control of system pressure, deaeration and water make-up
- Manual and automatic operation
- Common fault output signal
- Input, for contact water meter
- RS-485 interface

- 2-line LCD display
- 2 status displays
- Integrated control of system pressure, deaeration and water make-up
- Manual and automatic operation
- Input, for contact water meter
- RS-485 interface

- 4.3" touch screen colour display
- Graphic user interface
- Simply structured plain text menus including operating instructions and help texts
- Integrated control of system pressure, deaeration and water make-up
- Manual and automatic operation
- Permanent display of the most important operating parameters in the system diagram
- Intelligent Plug & Play operational management
- Evaluation and storage of the most important operational data
- Extensive interfaces:
 - Input, for contact water meter
 - 2 x dry contact outputs for error messages
 - 2 x analogue outputs for pressure and vessel content
 - 2 x RS-485 interfaces
 - Plugs for Bluetooth module, HMS networks and KNX module, as well as SD card



For Control Touch:



Reflexomat

Pressurisation unit compressor-controlled

The safety valve
protects the vessel from excessive pressure.

Lifting lugs
for ease of transport on site (1000 litres and above)



Inner anti-corrosion lining

MBM II bladder rupture detector
(option)

Bladder
High-quality butyl, reliably protects the expansion water from exposure to air

Tank
Heavy duty steel with durable epoxy coating , available in 6 and 10 bar

The flex connection
for the expansion line is a prerequisite for the proper operation of the level control

The load cell (fluid level measurement)
allows the operator to determine the filling level

Most reliable and silent Compressor to accommodate up to 12 MW input each



Control unit
State-of-the-art controls both in function and design. Guarantees maximum operating comfort. All reflex controls (Variomat, Reflexomat, Servitec, Variomat Giga) have been designed according to a uniform design guideline

The solenoid valve
is TÜV-tested and consequently satisfies the requirements of DIN 4751 T2 for systems up to 120°C

Pressure sensor

Robust mounting skid for compressor and control unit

For Control Touch:



Reflexomat

Reflexomat System With 1 & 2 Compressors

Reflexomat up to 12 MW with 1 compressor

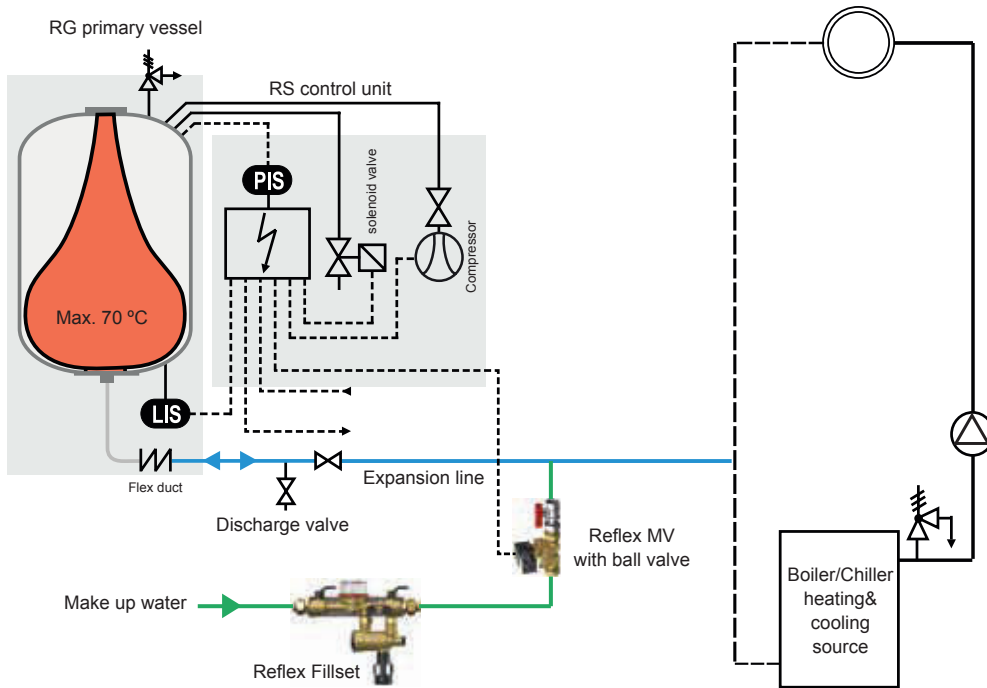

PIS Pressure maintenance, compensating for the expansion volume

The compressor and solenoid valve are actuated in such a way that if pressure is maintained at approximately ± 0.1 bar, the expansion water flowing in or out via expansion line P is compensated for in the basic vessel. Because pressure is "stored" in the form of an air buffer in the expansion vessel (basic vessel), the method of operation is very gentle. Reflexomats with 2 compressors work with load-based, automatically alternating operation and automatic malfunction switchover.

Note: The useful volume rate is 90 % for the compressor controlled pressurisation units. Therefore according to calculations the required expansion tank size is smaller than static tank size.

Reflexomat up to 24 MW with 2 compressors

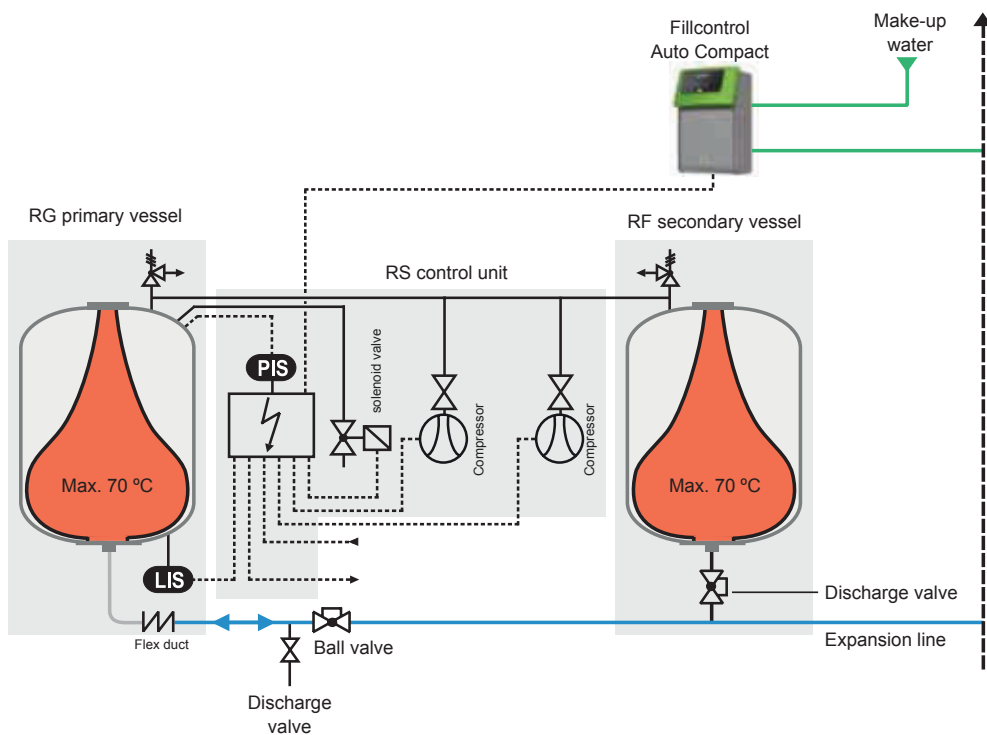

LIS Water make-up

Water make-up in the event of system-based water losses is integrated into the Reflexomat controls. It is performed based on the filling level in the basic vessel. The level measurement is carried out by evaluating the weight of the basic vessel. The solenoid valve for water make-up and the Reflex Fillset with water meter and system separator can be ordered optionally. Water make-up is monitored by a leakage monitor and interrupted in the event of any malfunctions. The signals of a contact water meter can be evaluated (Reflex Fillset with contact water meter). The Reflex Fillcontrol Auto make-up station with integrated pump is available for very high system pressures.

Reflexomat Working Principle

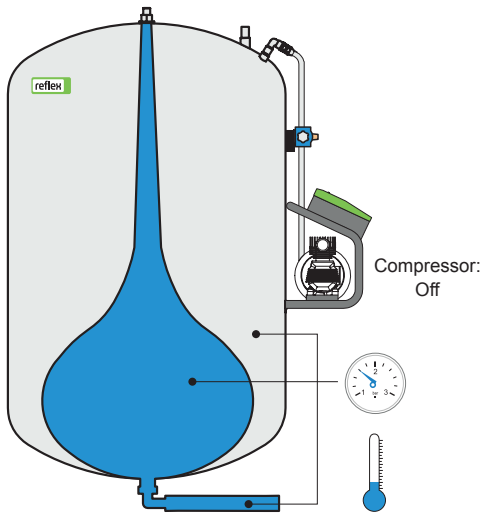

1. Low Temperature

The unit contains a small amount of water. The unit is in rest.

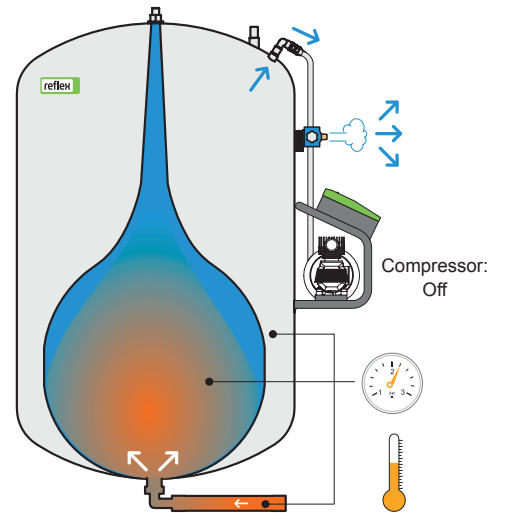

2. Temperature increase

The volume of water, and thus the system pressure, increases. The controller responds to this by discharging air from the vessel and, as a result, the expansion water flows into the bladder.

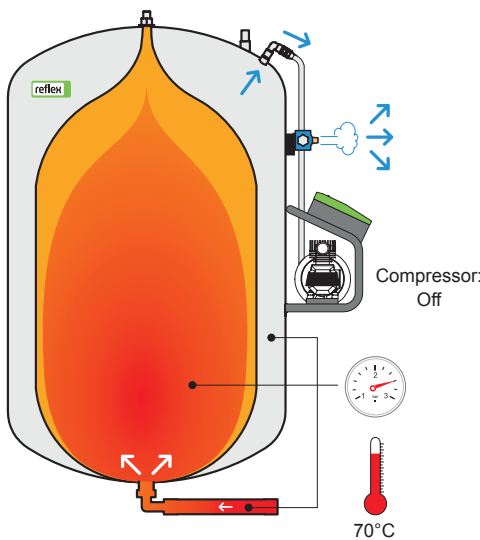

3. Full power

By storing increasing amounts of water in the vessel the controller keeps the system pressure at a constant level. When the system has warmed up completely, the vessel will be almost full to capacity.

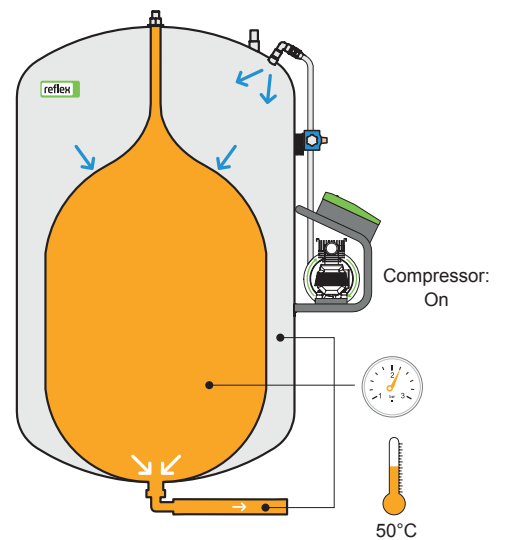

4. Cooling down

When the volume of water and thus the system pressure decreases, the controller will respond by increasing the air pressure in the vessel with displacement of water back into the system as a result. This restores equilibrium in the system pressure.

Reflexomat Compact

- Compact Compressor-controlled pressurisation unit for heating and chilled water systems
Air cushion compartment has anti-corrosion lining
- Compact design
- Meets or exceeds EC norms for pressure vessels 97/23/EC
- **Butyl** diaphragm according to DIN EN 13831 norm part 3, max. operating temperature 70°C
- Maintains the pressure level within +/- 0.1 bar boundary
- Design pressure 6 bar
- Max. system flow temperature 120°C*
- Degree of protection: IP 54
- With Control Basic
- Power supply 230 V
- 1 dry contact (BMS common fault signal)
- Featuring RS 485 interface
- **Minimat**, now with it's new name **Reflexomat Compact**



Formerly, Minimat	Type	Article No	Material Group	Ø D mm	H mm	h mm	System Connection	Weight
	RC 200	8806405	31	634	1320	135	R 1	52.0
	RC 300	8801705	31	634	1620	135	R 1	69.0
	RC 400	8802805	31	740	1620	135	R 1	80.0
	RC 500	8803705	31	740	1745	135	R 1	93.0

↑ V_n Nominal Volume [litres]

Reflexomat Compact With Make-up System

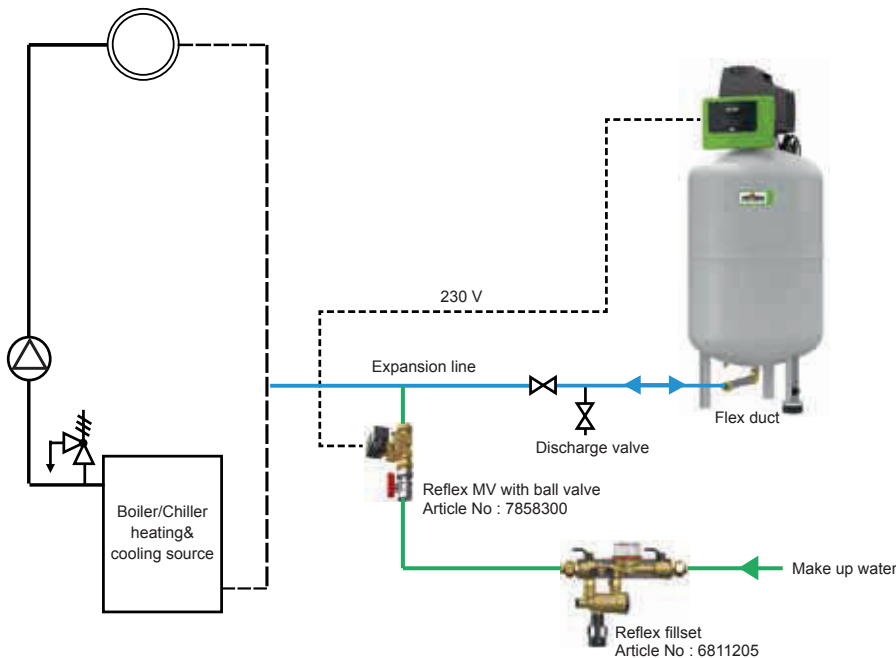

Reflexomat Compact with replenish

Reflexomat Compact in combination with MV (solenoid valve) and Fillset RPZ valve. If the water level in the vessel drops to a critical level, an appropriate amount of water will be filled into the unit from the water mains. MV solenoid valve to be connected to the control unit to have signal for replenish.

The Fillset RPZ valve protects against backflow, providing protection against the contamination of mains cold water supply according to EN1717.

Reflexomat - Compressor - Controlled Dynamic Pressure Maintenance

- Compressor-controlled pressurisation system for heating and chilled water systems up to 120°C max. flow temperature
- Maintains the pressure level within +/- 0.1 bar boundary
- Meets or exceeds EC norms for pressure vessels 97/23/EC
- Superior quality butyl bladder according to German DIN EN 13831 norm part 3, max. operating temperature 70°C
- Microprocessor control with display in 8 languages
- Permanent display of system pressure and tank volume level
- 230 V output for fully automated water make-up
- 2 dry contacts (common fault, min. water level)
- Data output through RS-485 (from VS 90/2 and VS 150)
- Durable epoxy coating with attractive new colour



Reflexomat 200-600



Reflexomat RS 300/1

RG 1000

For Control Touch:



Reflexomat, Degassing and Water Make-up With Servitec

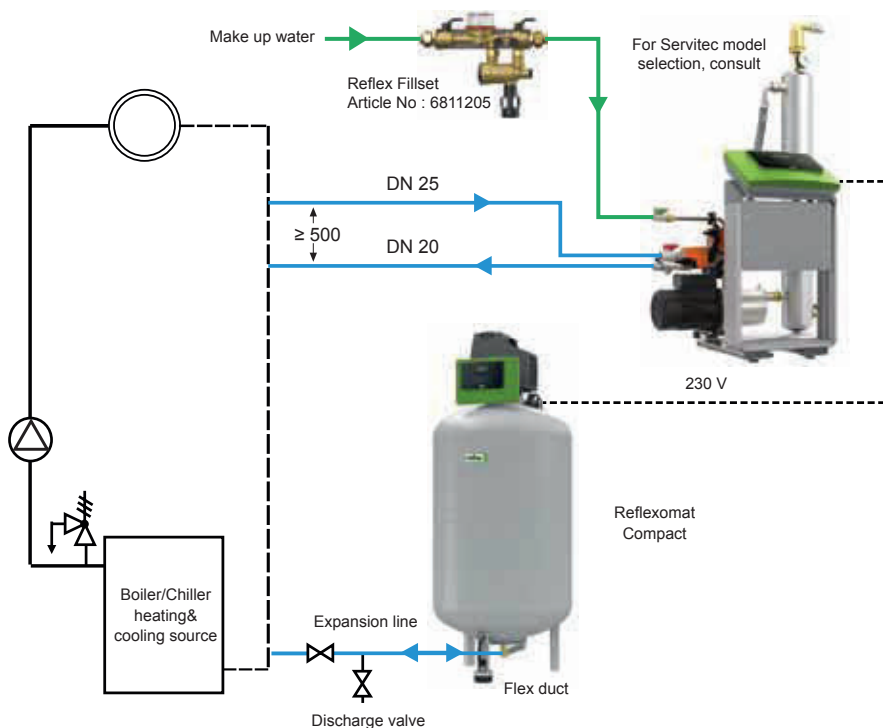

Reflexomat with Servitec

Reflexomat unit in combination with Servitec and Fillset RPZ valve. If the water level in the vessel drops to a critical level, an appropriate amount of water will be filled into the unit from the water mains via the Servitec device. By connecting the Servitec device in Levelcontrol mode to the Reflexomat control unit, make-up water is de-aerated before going into the system.

The Fillset RPZ valve protects against back-flow, providing protection against the contamination of mains cold water supply. This combination can also be used for applications where the water supply comes from an adjacent container, as the Servitec device is self priming.

Reflexomat Control Unit

- Compressor-controlled pressurisation unit for heating and chilled water systems
- Degree of protection: IP 54
- Power supply 230/400 V
- Common fault signal and RS 485 interface
- Control Touch from RS 150 as standard, control basic S as alternative
- Control Touch: graphic menu display, permanent display of the operating parameters, extensive interfaces, e.g. for BMS connection, remote monitoring
- VS Control Unit, now with it's new name RS Control Unit

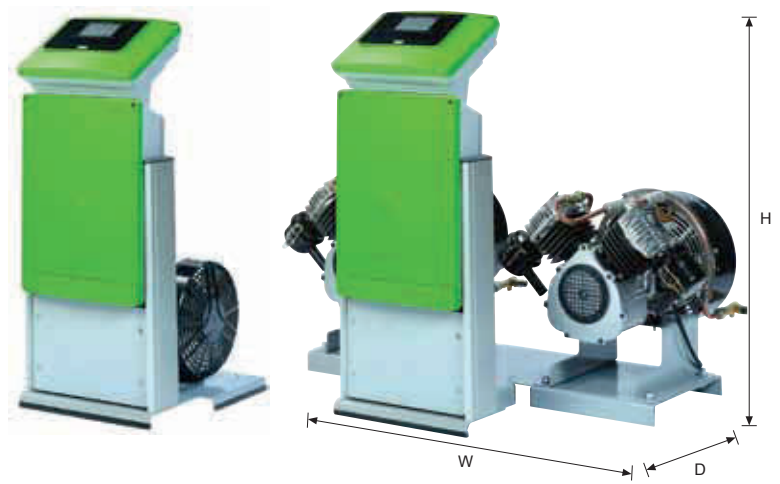

1 Compressor Unit

2 Compressor Unit

For Control Touch:



RS control unit with 1 compressor

Type	Control Touch Article No	Control Basic S Article No	Material Group	Height (H) mm	Width (W) mm	Depth (D) mm	Weight kg	Compressor
RS 90/1	8880111*	-	33	415	395	520	21.0	≤ 600 l, RS 90/1 on vessel
RS 90/1	8880211*	-	33	690	395	345	25.0	≥ 800 l, RS 90/1 adjacent
RS 150/1	8880311	8880010	33	920	395	600	28.0	adjacent
RS 300/1	8880411	8880020	33	920	395	700	34.0	
RS 400/1	8880511	8880030	33	920	395	700	51.0	
RS 580/1	8880611	8880040	33	920	395	700	102.0	

* Control basic only

RS control unit with 2 compressors

Type	Control Touch Article No	Control Basic S Article No	Material Group	Height (H) mm	Width (W) mm	Depth (D) mm	Weight kg	Compressor
RS 90/2	8882100	8882000	33	920	1225	800	33.0	adjacent
RS 150/2	8883100	8882010	33	920	1225	800	45.0	
RS 300/2	8884100	8882020	33	920	1225	800	61.0	
RS 400/2	8885100	8882030	33	920	1225	800	95.0	
RS 580/2	8886100	8882040	33	920	1225	800	197.0	

Voltage operation: RS 90 → 230 V/50 Hz, from RS 150 → 400 V/50 Hz

Reflexomat Control Unit Without Compressor (For On Site Compressed Air)

Type	Article No	Material Group	H/W/D (mm)*	Weight kg*
≤ 600 litre, RS 90/1	8881100	33	415/395/520	9.0
> 800 litre, RS 90/1	8881105	33	690/395/345	9.0

* Without compressor

Solenoid Valve For On-site Compressed Air

Fitted ready-to-connect in the RS 90/1 control unit without compressor

MV ¼ **Article No:** 7913000 **Material Group:** 35

Reflexomat Vessels

- Heavy duty steel tank
- Replaceable **butly** bladder in accordance with DIN EN 13831
- Approval in accordance with the Pressure Equipment Directive 97/23/EC
- Max. operating temperature bladder: 70°C
- Max. system flow temperature: 120°C
- Durable epoxy coating with attractive new colour

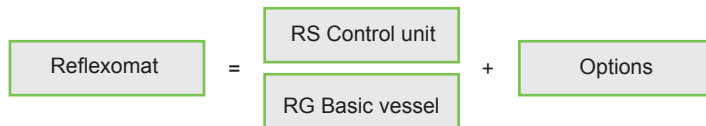
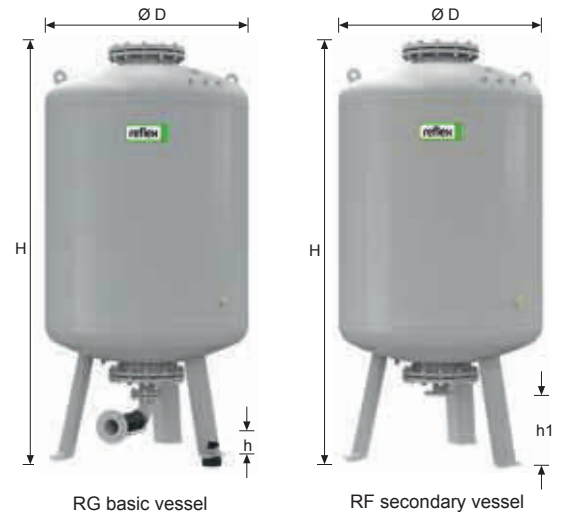

6 bar	RG basic vessel			RF secondary vessel (optional)		Article Group	Ø D mm	H mm	Connection	HG mm	Weight kg
	Type 6 Bar	h mm	Article No	h1 mm	Article No						
	200	115	8799100	155	8789100	30	634	970*	R 1	1350	42.8
	300	115	8799200	155	8789200	30	634	1270*	R 1	1650	60.7
	400	100	8799300	140	8789300	30	740	1255*	R 1	1640	69.4
	500	100	8799400	140	8789400	30	740	1475*	R 1	1860	78.7
	600	100	8799500	140	8789500	30	740	1720*	R 1	2110	90.1
	800	100	8799600	140	8789600	30	740	2185	R 1	-	110.3
	1000	195	8650105	305	8652005	32	1000	2025	DN 65	-	308.6
	1500	185	8650305	305	8652205	32	1200	2025	DN 65	-	328.0
	2000	185	8650405	305	8652305	32	1200	2480	DN 65	-	380.0
	3000	220	8650605	334	8652505	32	1500	2480	DN 65	-	795.0
	4000	220	8650705	334	8652605	32	1500	3065	DN 65	-	1.188.0
	5000	220	8650805	334	8652705	32	1500	3590	DN 65	-	1.115.0
10 bar	350	190	8654000	190	8654300	30	750	1340	DN 40	-	230.0
	500	190	8654100	190	8654400	30	750	1600	DN 40	-	275.0
	750	180	8654200	180	8654500	30	750	2185	DN 50	-	345.0
	1000	165	8651005	285	8653005	32	1000	2065	DN 65	-	580.0
	1500	165	8651205	285	8653205	32	1200	2055	DN 65	-	800.0
	2000	165	8651305	285	8653305	32	1200	2515	DN 65	-	960.0
	3000	195	8651505	310	8653505	32	1500	2520	DN 65	-	1.425.0
	4000	195	8651605	310	8653605	32	1500	3100	DN 65	-	1.950.0
	5000	195	8651705	310	8653705	32	1500	3630	DN 65	-	2.035.0

* Height, with RS 90/1 control unit included

Commissioning by Reflex - After Sales Service (Option)

Single compressor system **Article No:** 7945600

Double compressor system **Article No:** 7945630

Wall Bracket (Option)

- Wall mount facility for the RS 90/1 control unit in conjunction with RG 200, RG 300, RG 400, RG 500 and RG 600 expansion vessels (observe installation height H/HG)
- Incl. 3 m long connection hoses

Article No : 7881900

Material Group : 35



I / O Modules

- 2 x additional analogue outputs for system pressure and expansion vessel content monitoring
- 6 x freely programmable digital inputs
- 6 x freely programmable volt free outputs

Article No : 8858405

Material Group : 35



MBM II Bladder Rupture Detector

- For the signalling of bladder rupture in Reflexomat expansion
- Consists of a factory-mounted electrode and a relay
- Power supply 230 V / 50 Hz supply
- Three terminal dry contact
- Recommended: 1 device for each vessel

Article No : 7857700

Material Group : 86



Relay
For on site mounting



Electrode
Factory mounted

Bus Modules

- For data exchange between the Reflexomat unit (via RS 485) and BMS

LonWorks Digital	Article No : 8860000	Material Group : 86
LonWorks	Article No : 8860100	Material Group : 86
Profi bus-DP	Article No : 8860200	Material Group : 86
Ethernet	Article No : 8860300	Material Group : 86



Master - Slave Connection

- Software tool for operating up to 10 Reflexomats in a hydraulic group to a distance of 1000 m

Article No : 7859000

Material Group : 35

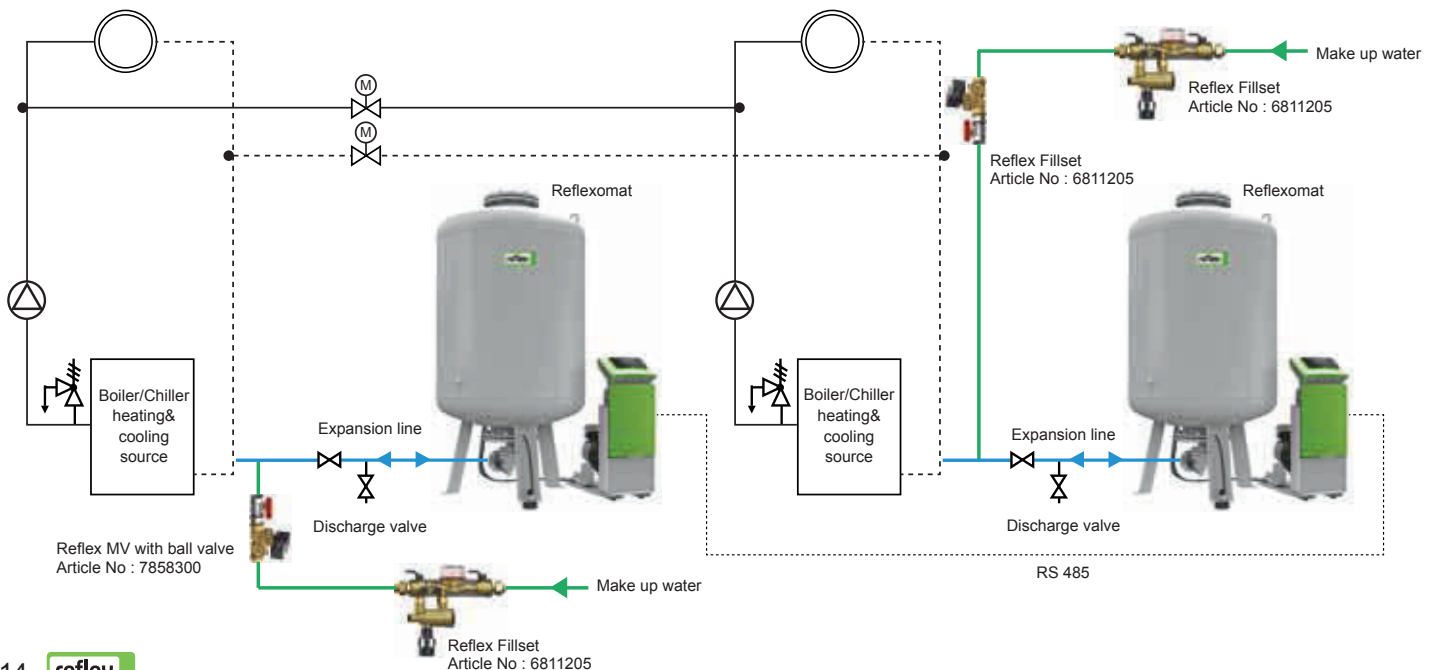

Options

Reflex MV Solenoid Valve With Ball Valve

- For water make-up within systems which are equipped with pressurisation units
- Operates on 230 V output from pressurisation unit

Article No : 7858300

Material Group : 35

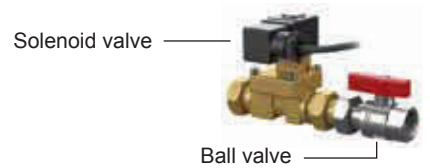

Reflex Fillset With Impuls Water Meter

- Pre-fabricated assembly for direct connection of HVAC systems to water mains
- Total quantity of make-up water is measured by a water meter
- Prevents backflow of HVAC water into the water mains
- With German DVGW-approved BA-type backflow preventer
- Including wall bracket and isolation valves

Article No : 6811205

Material Group : 70

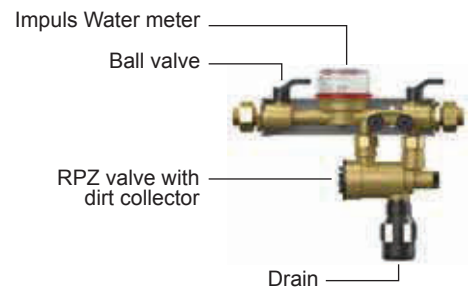

Reflexomat With Fillcontrol Auto Compact and Fillsoft II

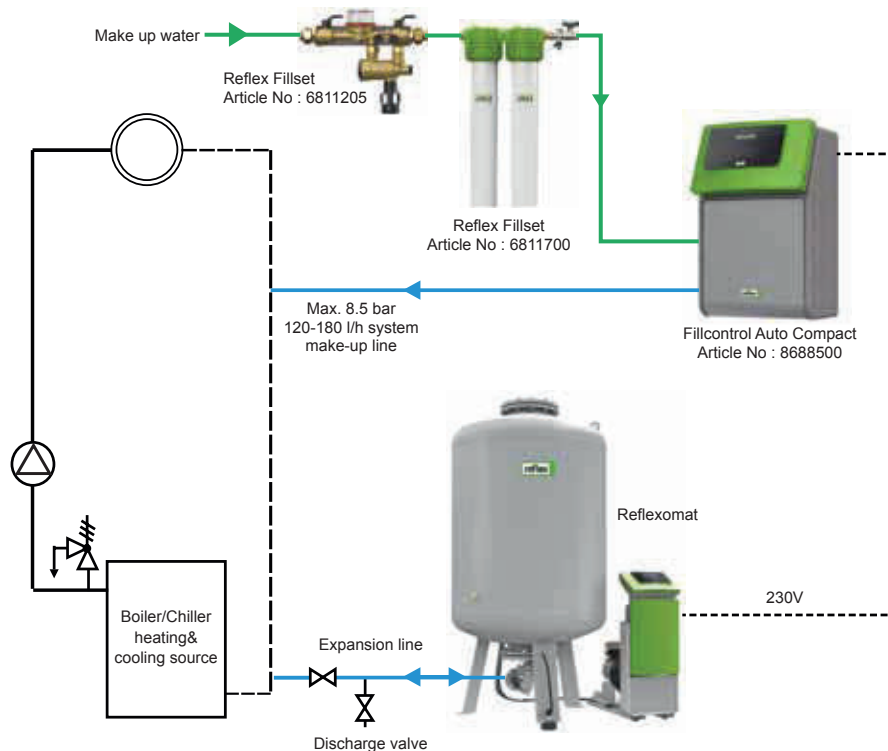

Reflexomat with Fillcontrol Auto Compact

Reflexomat unit in combination with Fillcontrol Auto Compact, Fillsoft II and Fillset RPZ valve. If the water level in the vessel drops to a critical level, an appropriate amount of water will be filled into the unit from the water mains via the Fillcontrol Auto Compact. By connecting the Fillcontrol Auto Compact make-up unit to the Reflexomat control unit, make-up water is pumped into the system, if the pressure from the water mains is below system pressure. The make-up unit also include a break tank, which providing protection against contamination. By the Fillsoft device the system water can be totally softened or adjusted to the required level. The Fillset RPZ valve protects against backflow, providing protection against the contamination of mains cold water supply according to EN1717. By connecting the impuls water meter to the Variomat control unit the Fillmeter function is available.

Reflexomat Quick Selection

1 Compressor

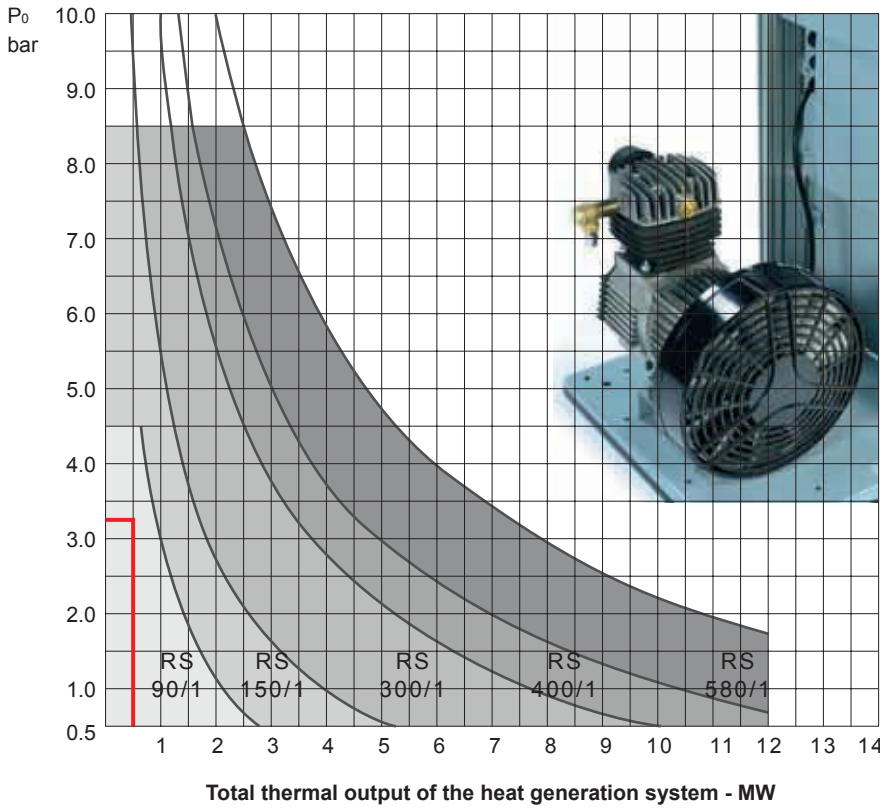

Selection Example

Output heat generator $Q = 500 \text{ kW}$
 Water content $V_a = 5000 \text{ litres}$
 Design temperature $T = 70/50 \text{ }^\circ\text{C}$
 Static height $H_{st} = 30 \text{ m}$
 Expansion coefficient $n = 0.0228$

$$P_0 \geq \frac{H_{st} [\text{m}]}{10} \text{ bar} + 0.2 \text{ bar}$$

$$P_0 \geq \frac{30}{10} \text{ bar} + 0.2 \text{ bar} = 3.2 \text{ bar}$$

$$V_n \geq \frac{V_{ex} + V_{WR}}{F_{acc}}$$

$$V_n \geq \frac{5000 \times (0.0228 + 0.005)}{0.9} = 155 \text{ liter}$$

Selected:

Control unit RS 90/1
 Expansion vessel RG 200
 SU Lock shield R 1x1

2 Compressors

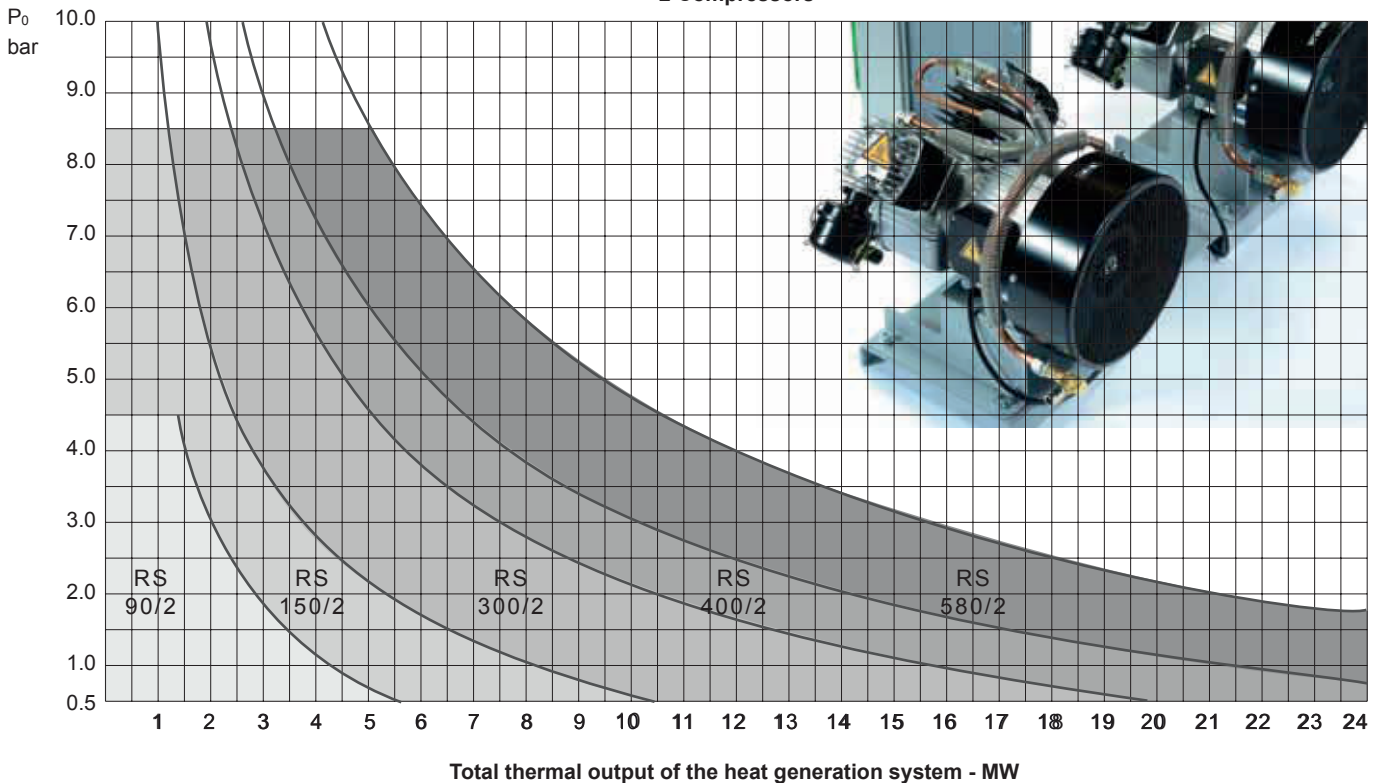

Variomat

Pump Controlled Pressurisation Systems

- Pressure maintenance
- Deaeration
- Water make-up

For Control Touch:



Control Unit

Control Basic



- 2-line LCD display
- 8 control keys
- 2 status displays
- Integrated control of system pressure, deaeration and water make-up
- Manual and automatic operation
- Common fault output signal
- Input, for contact water meter
- RS-485 interface

Control Basic S



- 2-line LCD display
- 2 status displays
- Integrated control of system pressure, deaeration and water make-up
- Manual and automatic operation
- Input, for contact water meter
- RS-485 interface

Control Touch



- 4.3" touch screen colour display
- Graphic user interface
- Simply structured plain text menus including operating instructions and help texts
- Integrated control of system pressure, deaeration and water make-up
- Manual and automatic operation
- Permanent display of the most important operating parameters in the system diagram
- Intelligent Plug & Play operational management
- Evaluation and storage of the most important operational data
- Extensive interfaces:
 - Input, for contact water meter
 - 2 x dry contact outputs for error messages
 - 2 x analogue outputs for pressure and vessel content
 - 2 x RS-485 interfaces
 - Plugs for Bluetooth module, HMS networks and KNX module, as well as SD card



For Control Touch:



Variomat

Pump Controlled Pressurisation Systems

The expansion bend guarantees the pressure compensation towards the atmosphere between the vessel wall and the diaphragm

The expansion bend guarantees maximum operating comfort. All Reflex controls (Variomat, Variomat Giga, Reflexomat, Servitec) have been designed according to a uniform design guideline



The sounding pipe deaeration extracts the gasses from the tank and prevents de-aeration.

The high-quality butyl bladder protects the expansion water from a direct air admission

Heavy duty steel tank



MBM II bladder rupture detector (option)

The pressure expansion relief at atmospheric pressure results in the deaeration of the expansion water

The connection set connects the control unit with the VG basic vessel. For 1-pump systems, the protected shut-off is integrated in the connection set. With respect to 2-pump systems, the protected shut-off is located on the control unit

The pressure cell (level measurement) enables the determination of the vessel fill level



Pump
Most reliable and silent.
From VS 2 soft start pumps

Over-flow line
With patented motor ball-valve-Auto-function

Water make-up line
When the fill level in the VG basic vessel is too low, the solenoid valve opens. For a connection to the drinking water network, Fillset must be added

For Control Touch:



Variomat

Variomat Pressurisation Systems

Variomat 1 up to 2 MW with 1 pump

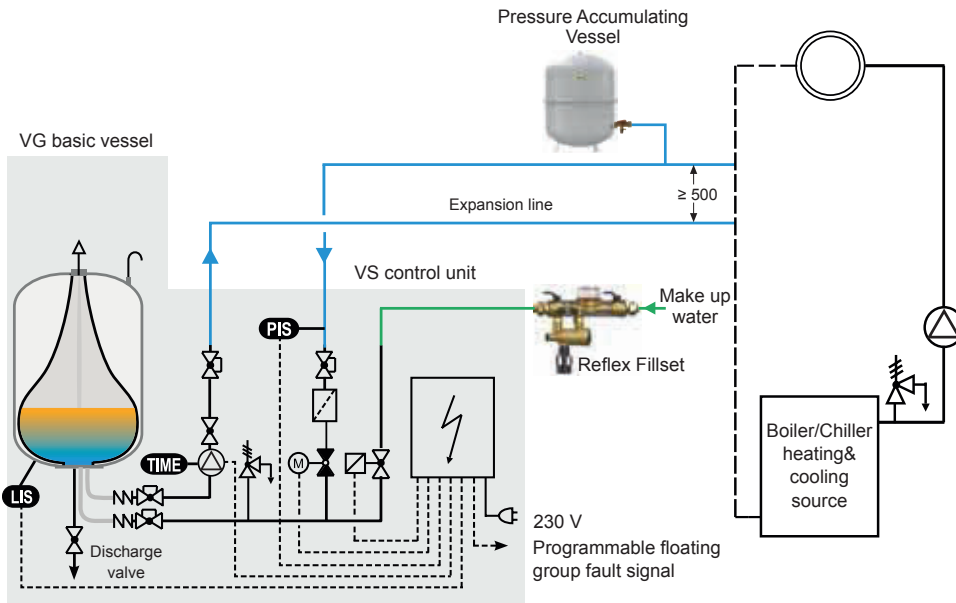

PIS Pressure maintenance, compensating for the expansion volume

The pump and overflow valve are actuated in such a way that pressure remains constant within a range of around ± 0.2 bar. The expansion water is supplied to or discharged from the depressurised basic vessel in 2 separate expansion lines.

LIS Water Make-up

The volume of discharged free gases and water losses are automatically replenished. The level measurement is carried out by evaluating the weight of the basic vessel. Water make-up based on the filling level in the basic vessel is monitored by a leakage monitor and interrupted in the event of any malfunctions. With the Variomat 2, the signals of a contact water meter can be evaluated (Reflex Fillset with contact water meter).

Variomat 2 - 1 up to 4 MW with 2 pumps

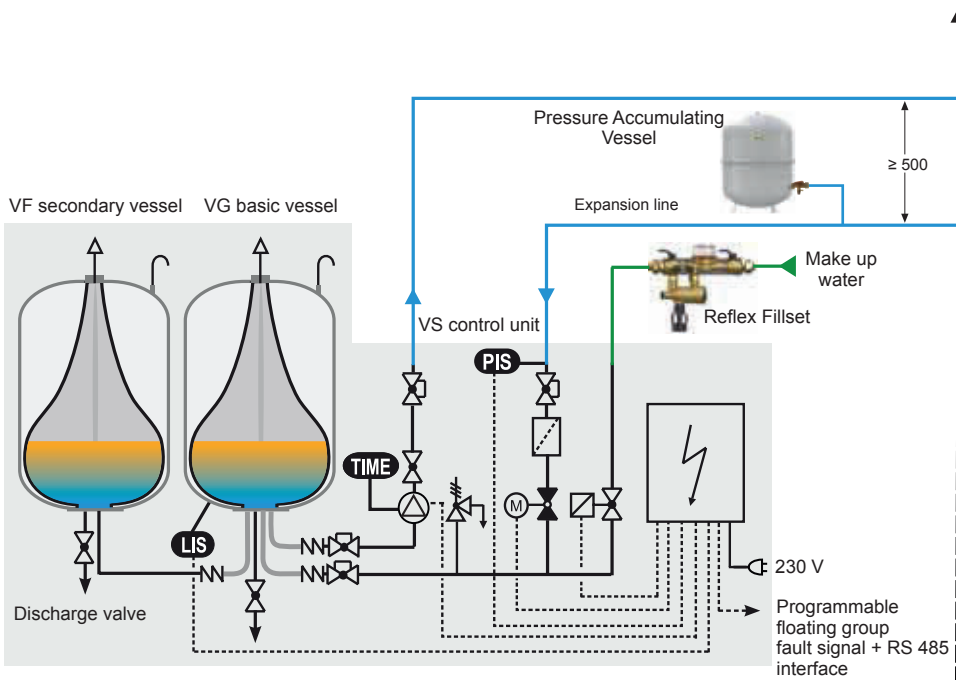

TIME Deaeration

A part flow of the heating water is released into the basic vessel and thus degassed. The deaeration mode can be selected from the following versions:

- Continuous deaeration: constant deaeration after startup and repairs in the supply system, to allow all residual air to be removed from the system.
- Follow-up deaeration: activated automatically after continuous deaeration and performed after every pump operation.
- Interval deaeration: performed after a specified schedule.

Note: The useful volume rate is 90 % for the pump controlled pressurisation units.

Therefore according to calculations the required expansion tank size is smaller than static tank size.

Variomat Working Principle

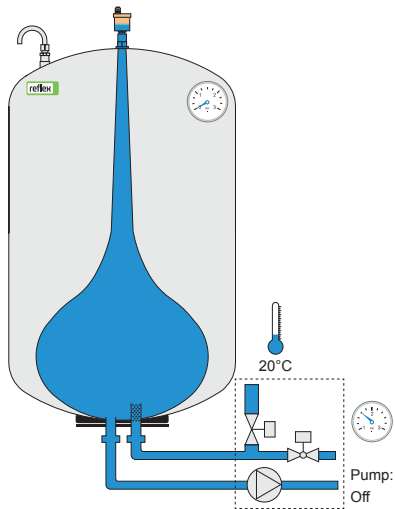

1. Low temperature

The unit contains a small amount of water. The unit is in rest.

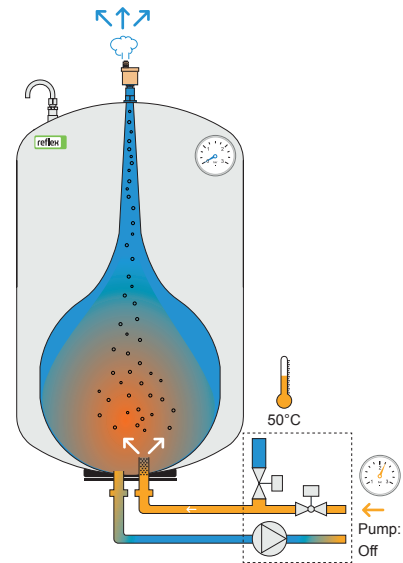

2. Temperature increase

The volume of water and the system pressure increase. The unit responds to this by opening the spill valve(s). Water flows into the pressureless vessel(s). The water in the vessel(s) is de-aerated due to the drop in pressure.

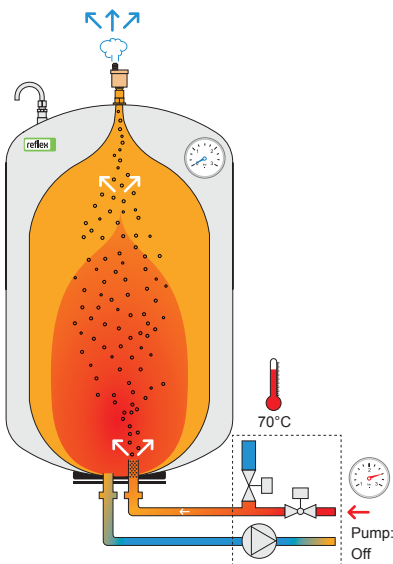

3. Full power

When the system has warmed up completely, the vessel will be almost full to capacity.

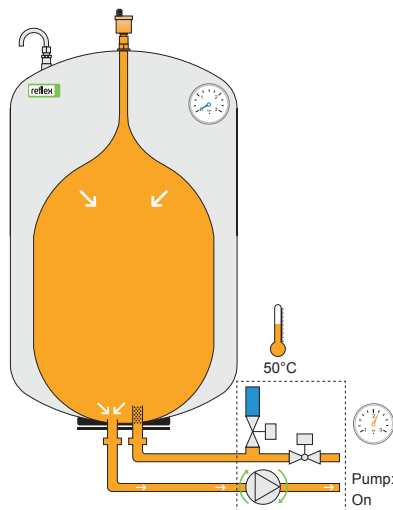

4. Cooling down

The volume of water and the system pressure decrease. The de-aerated water is pumped from the pressureless vessel back into the system. This restores the system pressure.

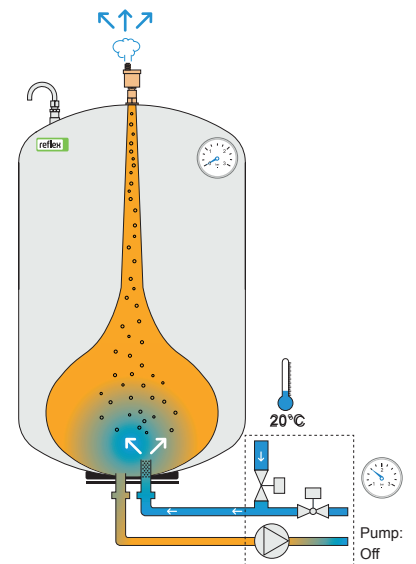

5. Replenish

If the water level in the vessel(s) drops to a critical level, an appropriate amount of water will be filled into the unit from the water mains. The water will be de-aerated (by pressure loss), before it's pumped into the system.

Variomat Control Units

- Variomat controller VS 1 with Control Basic
- From Variomat controller VS 2 with Control Touch and soft start
- Alternative, with control basic S
- Perm. advance temperature 120°C*
- Perm. operating temperature 70°C**
- Perm. ambient temperature 0 - 45°C
- Sound level approx. 55 dB
- Degree of protection: IP 54
- Water make-up connection Rp 1/2"
- Pump/overflow valve connection Rp 1/Rp 1
- Common fault signal and RS 485 interface



VS Control unit - 1 pump

Type	Control Touch Article No	Control Basic S Article No	Material Group	P ₀ bar	Height mm	Width mm	Depth mm	Connection	Weight kg
VS 1	8910100*	-	38	≤ 2.5	680	530	580	2 x G 1	25.0
VS 2-1/60	8910200	8910150	38	≤ 4.8	920	470	730	2 x G 1	33.0
VS 2-1/75	8910300	8910160	38	≤ 6.5	920	530	640	2 x G 1	35.0
VS 2-1/95	8910400	8910170	38	≤ 8.0	920	530	640	2 x G 1	37.0
VS 1-1/140	8910500	8910550	38	≤ 13.5	920	530	640	2 x G 1	50.0

* Control basic only

Voltage operation : 230 V / 50 Hz except VS 140 → 400 V / 50 Hz



VS Control unit - 2 pumps

Type	Control Touch Article No	Control Basic S Article No	Material Group	P ₀ bar	Height mm	Width mm	Depth mm	Connection	Weight kg
VS 2-2/35	8911100	8911610	38	≤ 2.5	920	700	780	2 x G 1 ¼	54.0
VS 2-2/60	8911200	8911620	38	≤ 4.8	920	700	780	2 x G 1 ¼	58.0
VS 2-2/75	8911300	8911630	38	≤ 6.5	920	720	800	2 x G 1 ¼	72.0
VS 2-2/95	8911400	8911640	38	≤ 8.0	920	720	800	2 x G 1 ¼	76.0
VS 1-2/140	8911500	8911650	38	≤ 13.5	920	720	800	2 x G 1 ¼	80.0

Variomat Pressurisation Systems

- Heavy duty steel tank
- Approval in acc. with the Pressure Equipment Directive 97/23/EC
- Replaceable **butyl** diaphragm in accordance with DIN EN 13831
- Max. system temperature 120°C
- Max. operation temperature 70°C
- Durable epoxy coating with attractive new colour

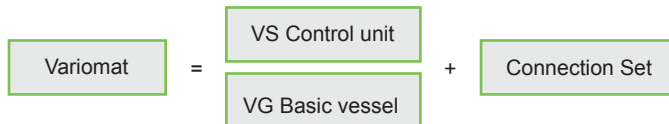

Type	VG Basic vessel Article No	VF secondary vessel Article No	Material Group	Ø D mm	H mm	h mm	Connection	Weight kg
200	8600011	8610000	36	634	1060	146	G 1	41.4
300	8600111	8610100	36	634	1360	146	G 1	52.2
400	8600211	8610200	36	740	1345	133	G 1	72.2
500	8600311	8610300	36	740	1560	133	G 1	81.8
600	8600411	8610400	36	740	1810	133	G 1	96.8
800	8600511	8610500	36	740	2275	133	G 1	109.9
1000 Ø 740	8600611	8610600	36	740	2685	133	G 1	156.0
1000 Ø 1000	8600705	8610705	37	1000	2130	350	G 1	292.8
1500	8600905	8610905	37	1200	2130	350	G 1	320.0
2000	8601005	8611005	37	1200	2590	350	G 1	565.0
3000	8601205	8611205	37	1500	2590	380	G 1	795.0
4000	8601305	8611305	37	1500	3160	380	G 1	1080.0
5000	8601405	8611405	37	1500	3695	380	G 1	1115.0

Commissioning by Reflex - After Sales Service (Option)

- Single pump system **Article No:** 7945600
- Double pump system **Article No:** 7945630

Variomat Connection Set

- For connecting Variomat pump systems to VG basic vessels with protected shut-offs and screw connections



Variomat Connection set - 1 pump

VG vessel (Ø/mm)	Article No	Material Group	Weight kg
480 - 740	6940100	39	2.0
1000 - 1500	6940200	39	3.0

Variomat Connection set - 2 pumps

VG vessel (Ø/mm)	Article No	Material Group	Weight kg
480 - 740	6940300	39	2.0
1000 - 1500	6940400	39	3.0

Thermal Insulation For Variomat Vessels

- 50 mm flexible foam thermal insulation with laminated orange PE cladding with zip fastener



VG Thermal Insulation

VW thermal insulation for VG basic vessels

Type	Article No	Material Group	Ø D mm	H mm	h mm	Connection	Weight kg
200	7985700	N39	634	1060	146	G 1	3.0
300	7986000	N39	634	1360	146	G 1	3.5
400	7995600	N39	740	1345	133	G 1	4.5
500	7983900	N39	740	1560	133	G 1	5.5
600	7995700	N39	740	1810	133	G 1	6.0
800	7993800	N39	740	2275	133	G 1	8.0
1000 Ø 740	7993900	N39	740	2685	133	G 1	8.0
1000 Ø 1000	7986800	N39	1000	2130	350	G 1	10.0
1500	7987000	N39	1200	2130	350	G 1	12.5
2000	7987100	N39	1200	2590	350	G 1	15.0
3000	7993200	N39	1500	2590	380	G 1	16.0
4000	7993300	N39	1500	3160	380	G 1	18.0
5000	7993400	N39	1500	3695	380	G 1	24.0

Master - Slave Connection

- Software tool for operating up to 10 Reflexomats in a hydraulic group to a distance of 1000 m

Article No : 7859000

Material Group : 35

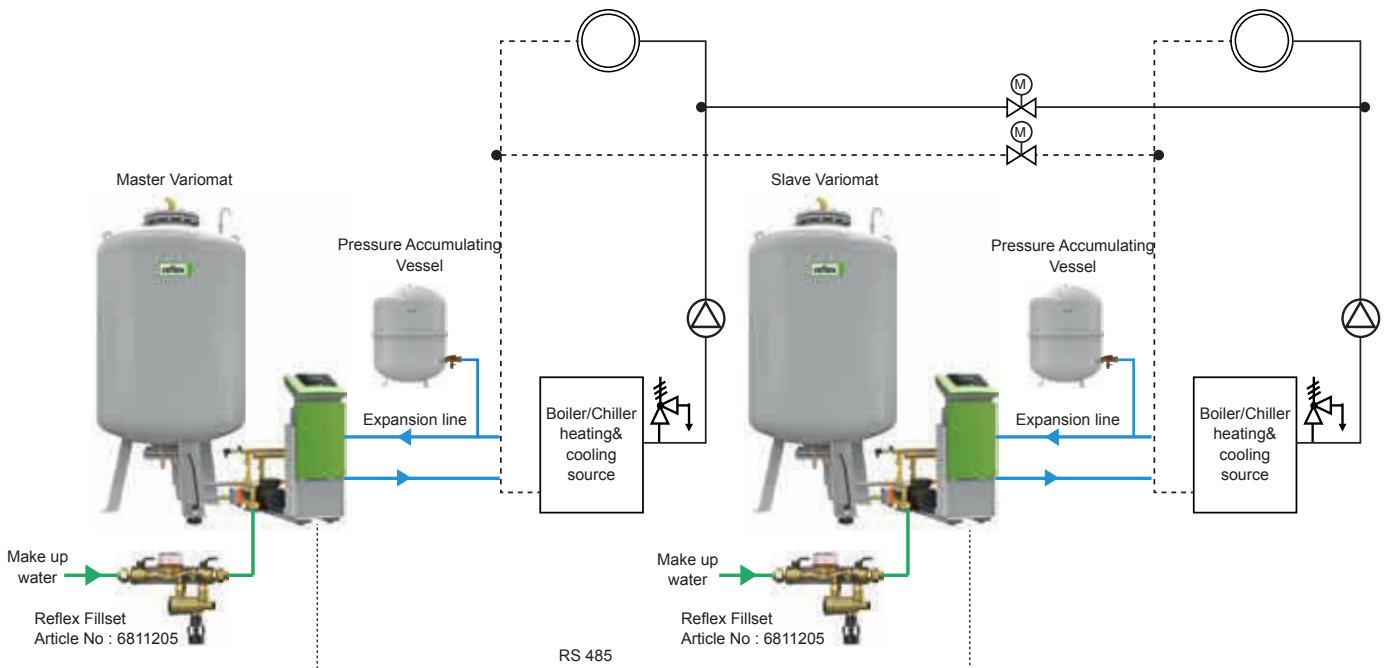

Variomat 1 water make-up with drinking water

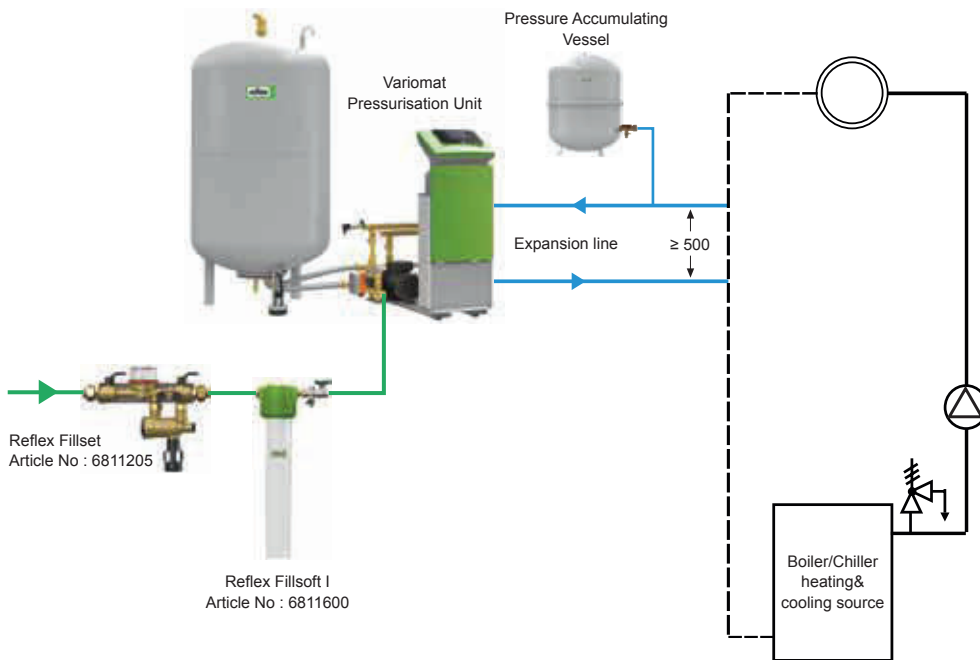

Fillsoft I

Variomat unit in combination with Fillsoft I water softening device and Fillset RPZ valve. If the water level in the vessel drops to a critical level, an appropriate amount of water will be filled into the unit from the water mains. By the Fillsoft device the system water can be totally softened or adjusted to the required level. The Fillset RPZ valve protects against backflow, providing protection against the contamination of mains cold water supply according to EN1717. By connecting the contact water meter to the Variomat control unit the Fillmeter function is available.

Variomat 2-1 water make-up via softening equipment

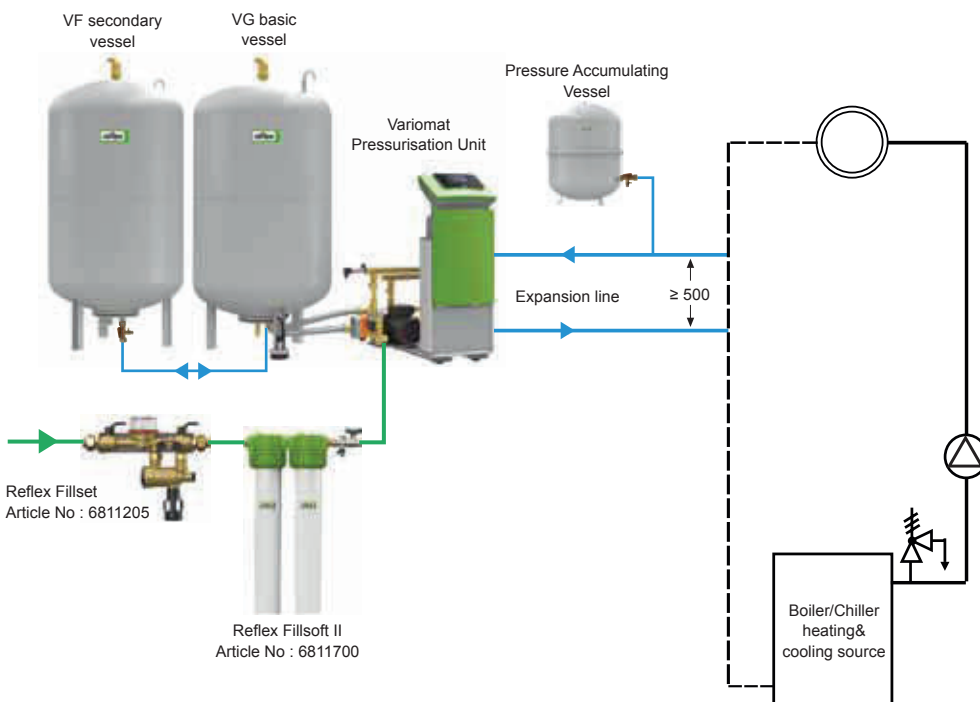

Fillsoft II

Variomat unit in combination with Fillsoft II water softening device for higher capacity and Fillset RPZ valve. If the water level in the vessel drops to a critical level, an appropriate amount of water will be filled into the unit from the water mains. By the Fillsoft device the system water can be totally softened or adjusted to the required level.

The Fillset RPZ valve protects against backflow, providing protection against the contamination of mains cold water supply according to EN1717. By connecting the contact water meter to the Variomat control unit the Fillmeter function is available.

Variomat Quick Selection

Selection Example

Output heat generator Q = 500 kW
 Water capacity V_A = 5000 litres
 Design temperature T = 70/50 °C
 Static height H_{st} = 30 m
 Expansion coefficient n = 0.0228

$$P_0 \geq \frac{H_{ST} [m]}{10} \text{ bar} + 0.2 \text{ bar}$$

$$P_0 \geq \frac{30}{10} \text{ bar} + 0.2 \text{ bar} = 3.2 \text{ bar}$$

$$V_n \geq \frac{V_{ex} + V_{rez}}{F_{acc}}$$

$$V_n \geq \frac{5000 \times (0.0228 + 0.005)}{0.9} = 155 \text{ liters}$$

Selected:

Control unit VS 2-1/60
 Expansion vessel VG 200
 Pressure Accumulating Vessel NG 80
 Connection set G 1"
 Make-up Reflex Fillset

- For cooling water systems up to 30°C only 50% of the nominal heating power should be considered when selecting the control unit
- In performance ranges > 2 MW we recommend using double pump systems

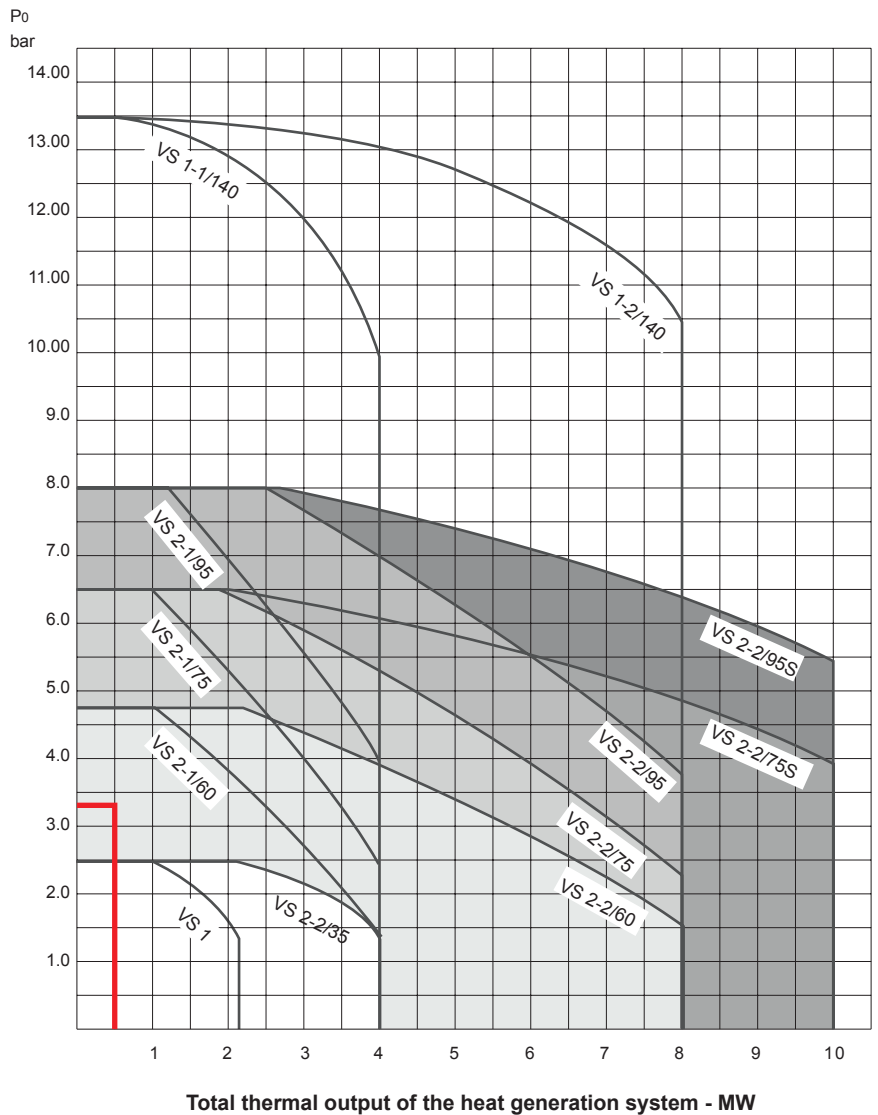

Variomat VG - VF Vessel Sizing

- Nominal volume V_n

Approximate value from the diagram →

or

Calculation acc. to formula ↓

$$V_n \geq V_A \times \begin{matrix} 0.031 [70^\circ\text{C}] \\ 0.045 [90^\circ\text{C}] \\ 0.054 [100^\circ\text{C}] \\ 0.063 [110^\circ\text{C}] \end{matrix}$$

Setting flow temperature ↑

V_n = Nominal volume, liter

V_A = System water content, liter

- The nominal volumes can be distributed to several vessels (VG basic vessel and VF secondary vessel).

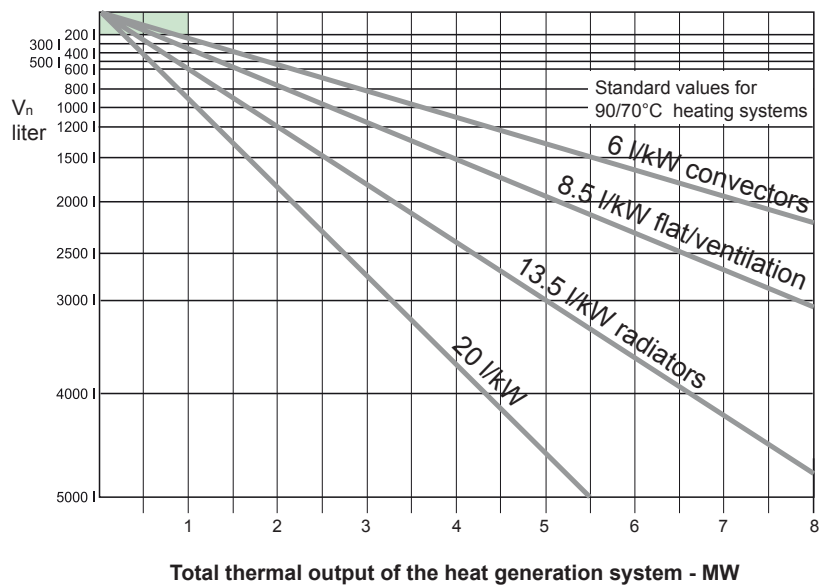

Variomat Giga

Pump Control Pressurisation Systems

- Pressure maintenance
- Deaeration
- Water make-up

For Control Touch:



Control Unit

Control Basic S



- 2-line LCD display
- 2 status displays
- Integrated control of system pressure, deaeration and water make-up
- Manual and automatic operation
- Input, for contact water meter
- RS-485 interface

Control Touch



- 4.3" touch screen colour display
- Graphic user interface
- Simply structured plain text menus including operating instructions and help texts
- Integrated control of system pressure, deaeration and water make-up
- Manual and automatic operation
- Permanent display of the most important operating parameters in the system diagram
- Intelligent Plug & Play operational management
- Evaluation and storage of the most important operational data
- Extensive interfaces:
 - Input, for contact water meter
 - 2 x dry contact outputs for error messages
 - 2 x analogue outputs for pressure and vessel content
 - 2 x RS-485 interfaces
 - Plugs for Bluetooth module, HMS networks and KNX module, as well as SD card



For Control Touch:



Variomat Giga

Pump Control Pressurisation Systems

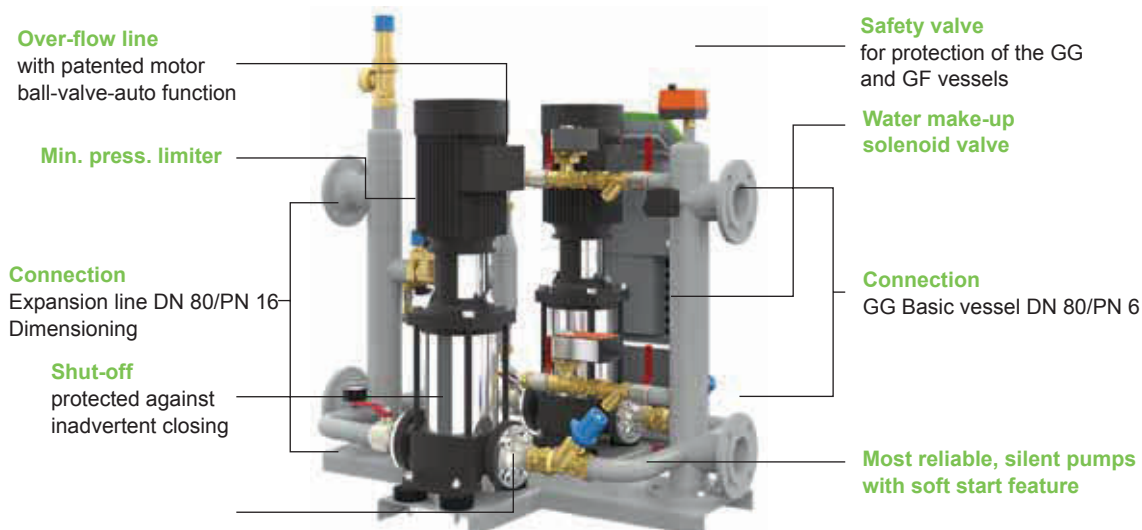
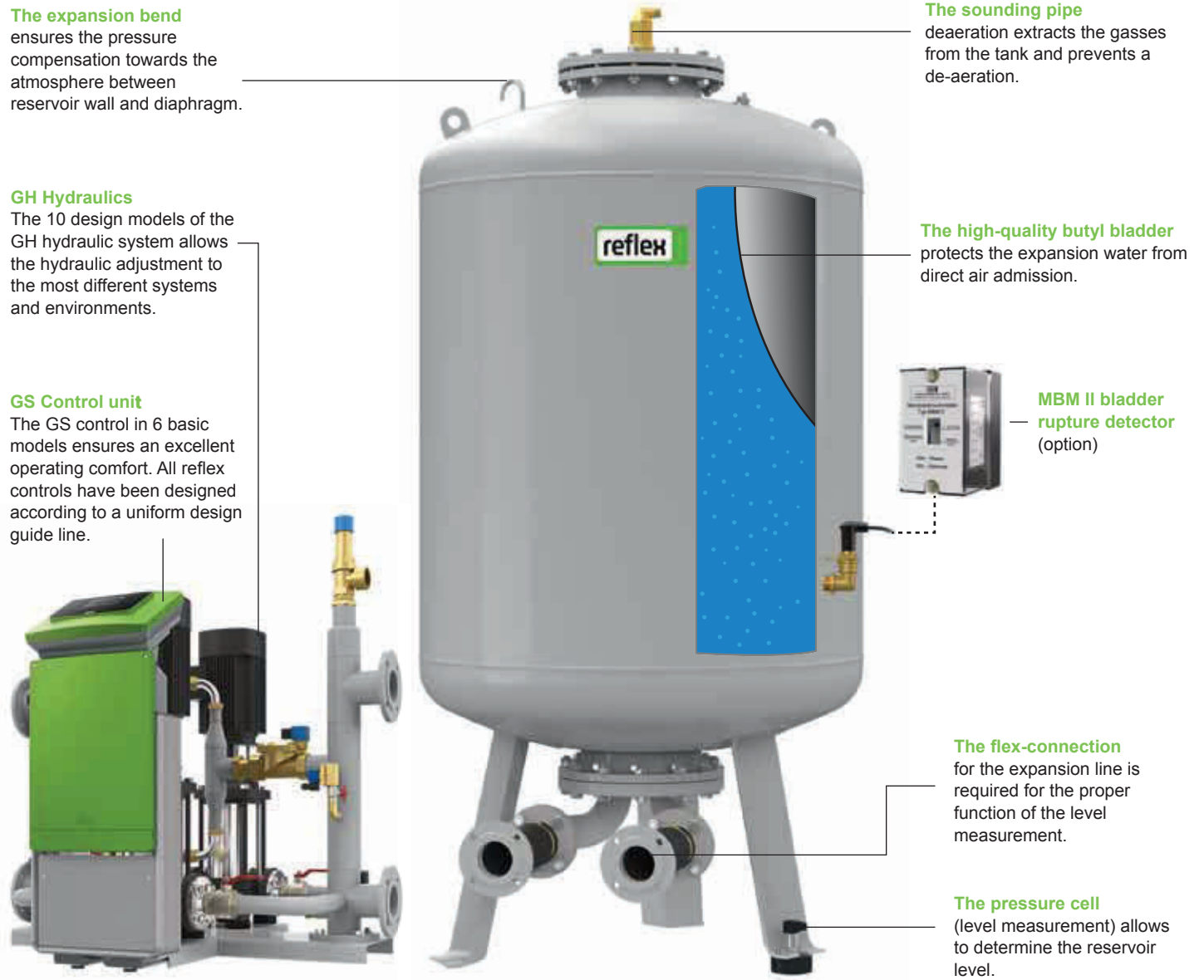

Variomat Giga

Variomat Giga Pressurisation Systems

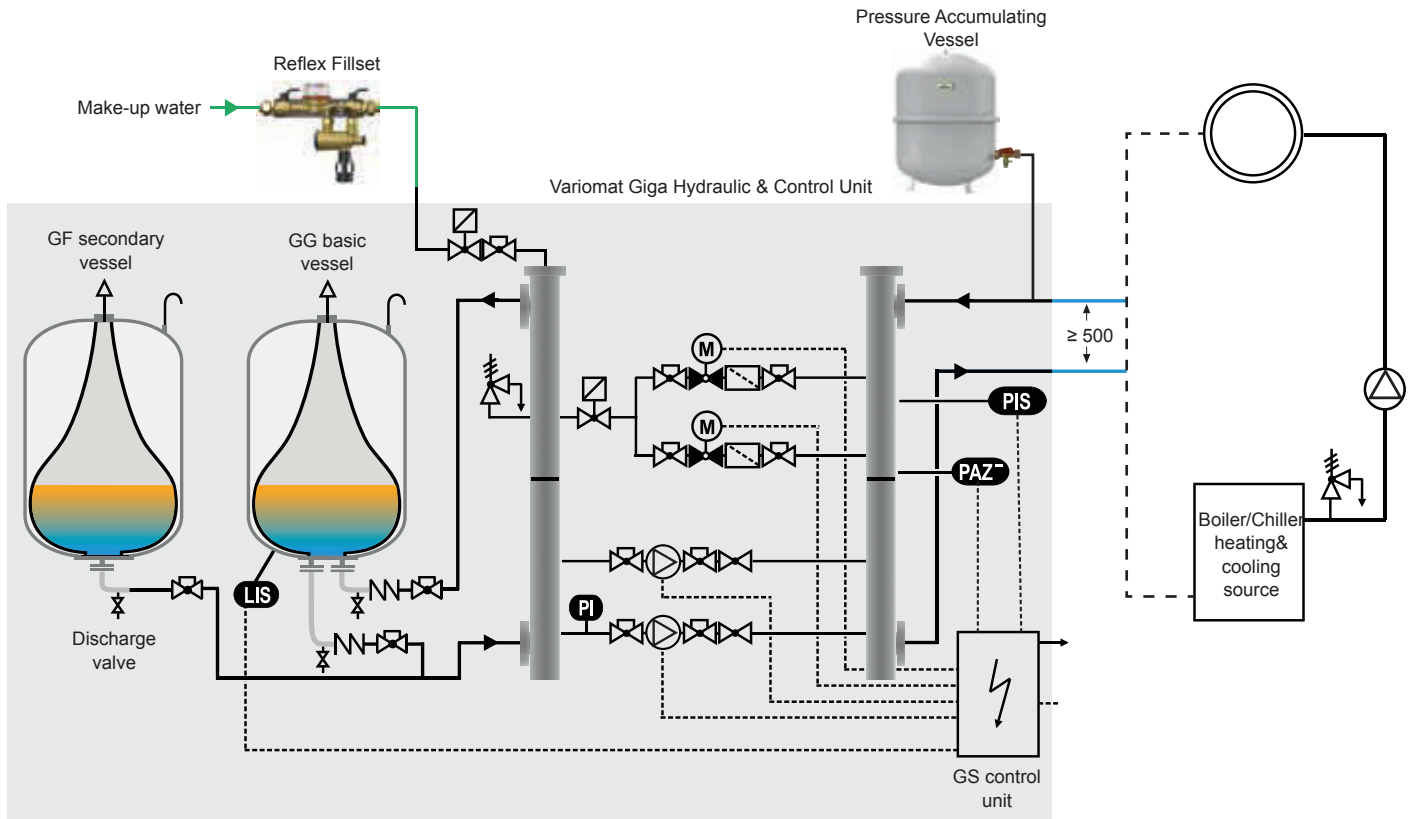

PIS Pressure maintenance, compensating for the expansion volume

The two pumps and two motorised ball valves are actuated in such a way that pressure remains constant within a range of around ± 0.2 bar. The expansion water is supplied to or discharged from the depressurised basic vessel in 2 separate expansion lines.

LIS Water make-up

The volume of discharged free gases and water losses are automatically replenished. The level measurement is carried out by evaluating the weight of the basic vessel. Water make-up based on the filling level in the basic vessel is monitored by a leakage monitor and interrupted in the event of any malfunctions. With the Variomat 2, the signals of a contact water meter can be evaluated (Reflex Fillset with contact water meter).

TIME Deaeration

A part flow of the heating water is released into the basic vessel and thus degassed. The deaeration mode can be selected from the following versions:

- Continuous deaeration: constant deaeration after startup and repairs in the supply system, to allow all residual air to be removed from the system.
- Follow-up deaeration: activated automatically after continuous deaeration and performed after every pump operation.
- Interval deaeration: performed after a specified schedule.

Note: The useful volume rate is 90 % for the pump controlled pressurisation units.

Therefore according to calculations the required expansion tank size is smaller than static tank size.



Variomat Giga Working Principle

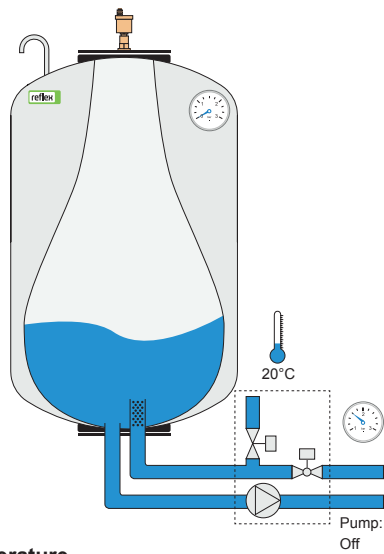

1. Low temperature

The unit contains a small amount of water. The unit is in rest.

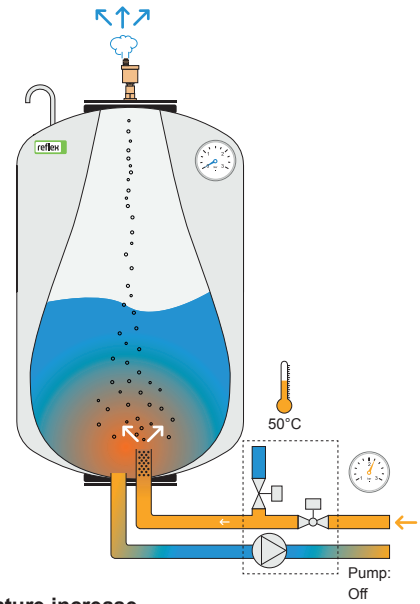

2. Temperature increase

The volume of water and the system pressure increase. The unit responds to this by opening the spill valve(s). Water flows into the pressureless vessel(s). The water in the vessel(s) is de-aerated due to the drop in pressure.

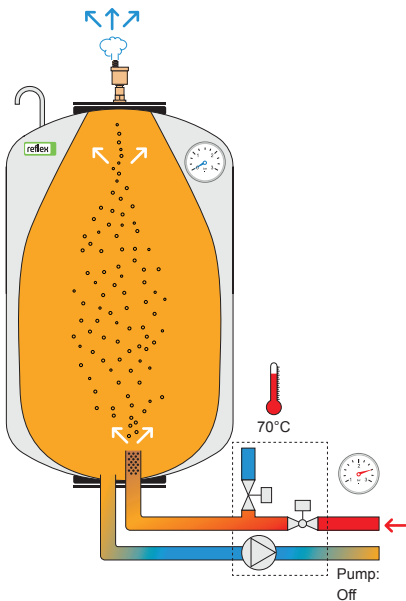

3. Full power

When the system has warmed up completely, the vessel will be almost full to capacity.

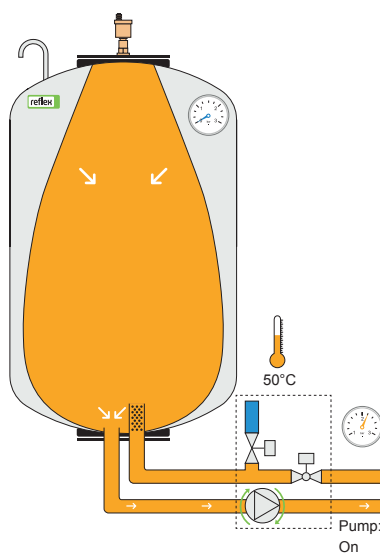

4. Cooling down

The volume of water and the system pressure decrease. The de-aerated water is pumped from the pressureless vessel back into the system. This restores the system pressure.

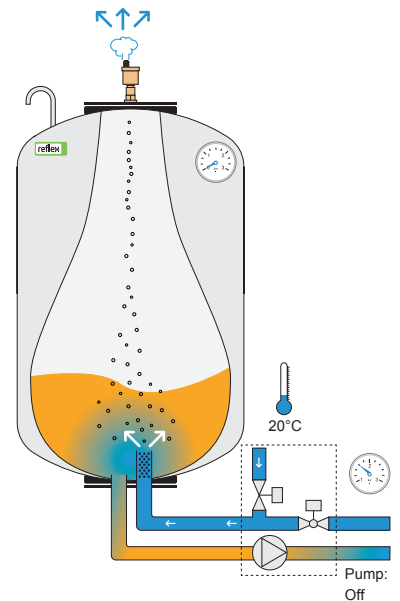

5. Replenish

If the water level in the vessel(s) drops to a critical level, an appropriate amount of water will be filled into the unit from the water mains. The water will be de-aerated (by pressure loss), before it's pumped into the system.

Variomat Giga Control Systems

- Pump-controlled pressurisation system with integral water-make-up and deaeration (RL ≤ 70°C) for heating and cooling water systems
- With 2 pumps and 2 overflow valves
- Max. excess operating pressure 16 bar
- Max. system temperature 120°C*
- Max. operating temperature 0–70°C**
- Sound level approx. 55 dB
- Pump connection DN 80/PN 16
- Basic vessel connection DN 80/PN 6
- Water make-up connection Rp 1/2
- Control Touch as standard, alternative Control Basic S
- Gigamat, now with it's new name Variomat Giga

For Control Touch:



Variomat Giga Control Unit

Control Module

Type	Control Touch Article No	Control Basic S Article No	Material Group	Electrical Power kW	Voltage	Hydraulic Module	Height mm	Width mm	Depth mm
GS 1.1	8912500	8912500	38	2.20	230 V/50 Hz	GH 50/GH 70	1200	1170	1020
GS 3	8912600	8912600	38	6.60	400 V/50 Hz	GH 90/GH100	1200	1170	830

Hydraulic Module

Type	Article No	Material Group	P ₀	Height mm	Width mm	Depth mm
GH 50	8931000	38	≤ 4.0	1200	1170	830
GH 70	8932000	38	≤ 6.0	1200	1170	830
GH 90	8931400	38	≤ 8.0	1200	1170	830
GH 100	8931200	38	≤ 9.5	1200	1170	830

Note: For bigger capacities models GH 110/130/140/150 could be selected (Page 35)

P₀ = Setting value on the control
 = static height + evaporation pressure + 0.2 bar (recommended)

* According to maximum possible setting value - Temperature control 105°C, in accordance with DIN EN 12828
 ** Installation in the system return, diaphragm load of expansion vessels max. 70°C. Please consult us for permanent temperatures of ≤ 0°C

Variomat Giga Tanks

- Heavy duty steel tank
- Approval in acc. with the Pressure Equipment Directive 97/23/EC
- Replaceable **butyl** diaphragm in accordance with DIN EN 13831
- Max. system temperature 120°C
- Max. operation temperature 70°C
- Max. operating pressure 6 bar
- Durable epoxy coating with attractive new colour

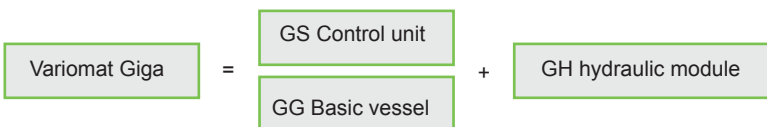
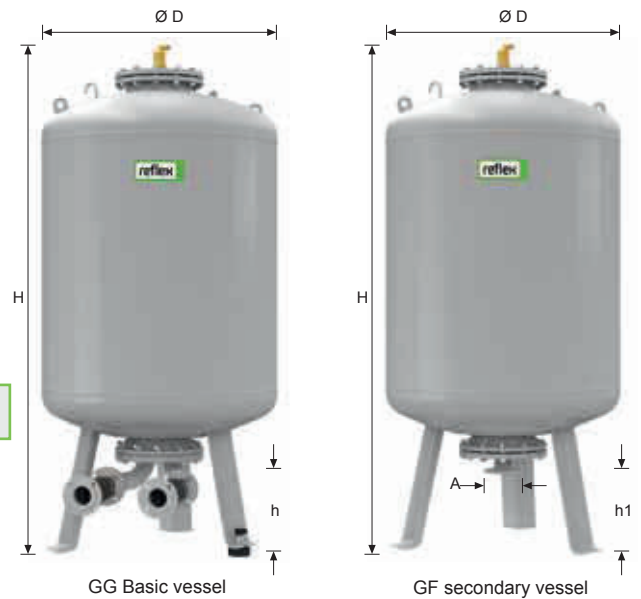

Type	GG Basic vessel Article No Grey	GF secondary vessel Article No Grey	Material Group	Ø D mm	H mm	h mm	h1 mm	A	Weight kg
1000	8920105	8930105	37	1000	2130	285	305	DN 65/PN 6	330.0
1500	8920305	8930305	37	1200	2130	285	305	DN 65/PN 6	465.0
2000	8920405	8930405	37	1200	2590	285	305	DN 65/PN 6	565.0
3000	8920605	8930605	37	1500	2590	314	335	DN 65/PN 6	795.0
4000	8920705	8930705	37	1500	3160	314	335	DN 65/PN 6	1.080.0
5000	8920805	8930805	37	1500	3695	314	335	DN 65/PN 6	1.115.0

Commissioning by Reflex - After Sales Service (Option)

Double pump system **Article No:** 7945630

I / O Module

- 2 x additional analogue outputs for controlling pressure and level
- 6 x freely programmable digital inputs
- 6 x freely programmable floating outputs
- Standard in the GS 3 Variomat Giga controller
- RS 485



For Variomat Article No : 8997705
For Variomat Giga Article No : 8997700

Master - Slave Connection

- Software tool for operating up to 10 Variomat systems in a hydraulic group to a distance of 1000 m

Article No : 7859100

MBM II Bladder Rupture Detector

- For the signalling of bladder rupture in Variomat Giga pressurisation systems
- Consists of a relay and a factory-mounted electrode
- Operates 230 V / 50 Hz supply
- Three terminal dry contact
- Recommended: 1 device for each vessel

Article No : 7857700



Relay
Wall mounted



Electrode
Factory mounted



Bus Modules

- For data exchange between the controller (RS 485) and the central building control system

LonWorks Digital	Article No : 8860000	Material Group : 86
LonWorks	Article No : 8860100	Material Group : 86
Profi bus-DP	Article No : 8860200	Material Group : 86
Ethernet	Article No : 8860300	Material Group : 86



The circuits must be adjusted to suit local conditions

Giga Connect

- To extend output and for parallel switching of 2 hydraulically directly connected Variomat Giga systems

On request

SV1 Safety Valve

- For additional protection of GG and GF vessels at nominal heating outputs > 10.5 MW

Article No : 6942100 **Material Group :** 81



Variomat Giga With Servitec

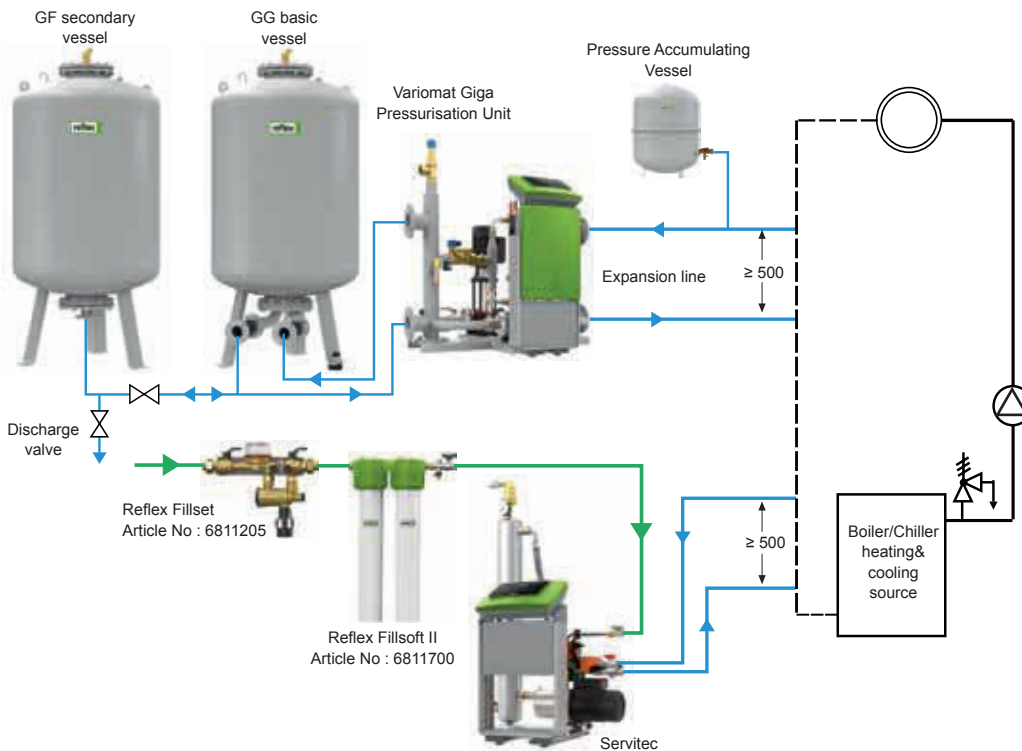

Variomat Giga unit in combination with Servitec and Fillset RPZ valve. If the water level in the vessel drops to a critical level, an appropriate amount of water will be filled into the unit from the water mains via the Servitec device. By connecting the Servitec device in Levelcontrol mode to the Variomat Giga control unit, make-up water is de-aerated before going into the system.

The Fillset RPZ valve protects against backflow, providing protection against the contamination of mains cold water supply according to EN1717. By the Fillsoft device the system water can be totally softened or adjusted to the required level. By connecting the contact water meter to the Variomat Giga control unit the Fillmeter function is available. This combination can also be used for applications where the water supply comes from an adjacent container, as the Servitec device is self priming.

Variomat Giga With Softening Equipment

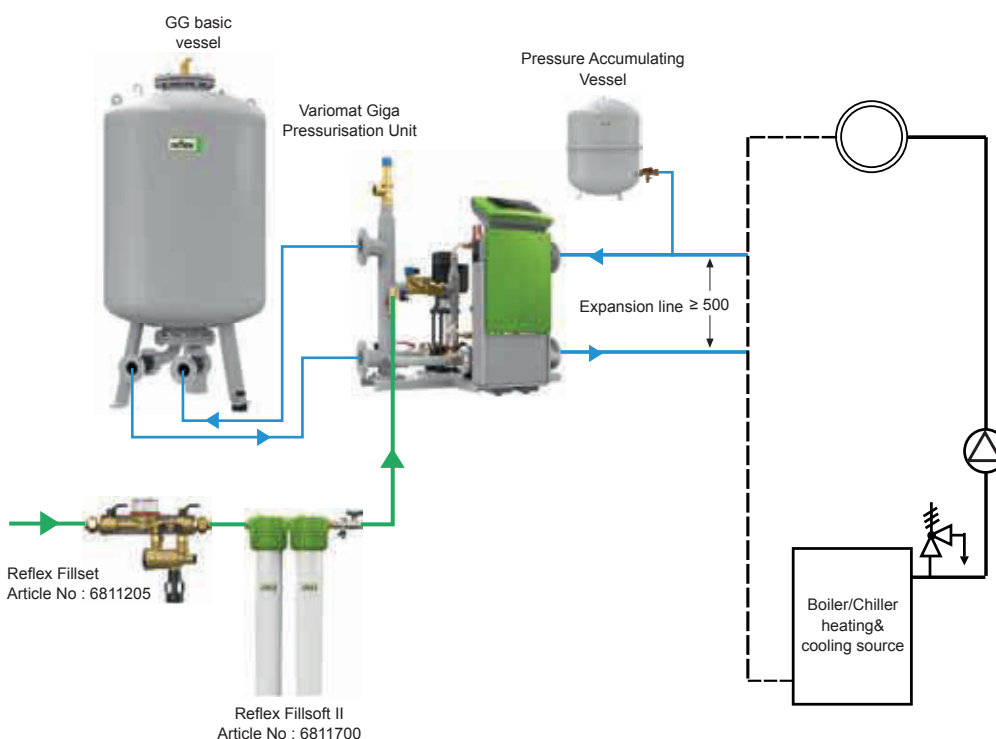

Variomat Giga unit in combination with Fillsoft II water softening device and Fillset RPZ valve. If the water level in the vessel drops to a critical level, an appropriate amount of water will be filled into the unit from the water mains. By the Fillsoft device the system water can be totally softened or adjusted to the required level.

The Fillset RPZ valve protects against backflow, providing protection against the contamination of mains cold water supply according to EN1717. By connecting the contact water meter to the Variomat control unit the Fillmeter function is available.

Variomat Giga Quick Selection

Selection Example

Output heat generator Q = 13 MW
 Water capacity V_A = 50.000 litres
 Design temperature T = 70/50 °C
 Static height H_{st} = 30 m
 Expansion coefficient n = 0.0228

$$P_0 \geq \frac{H_{st} [m]}{10} \text{ bar} + 0.2 \text{ bar}$$

$$P_0 \geq \frac{30}{10} \text{ bar} + 0.2 \text{ bar} = 3.2 \text{ bar}$$

$$V_n \geq \frac{V_{ex} + V_{rez}}{F_{acc}}$$

$$V_n \geq \frac{50/000 \times (0.0228 + 0.005)}{0.9} = 1545 \text{ liters}$$

Selected:

Control unit GS 1.1
 Hydraulic module GH 70
 Expansion vessel GG 2000
 Make-up Reflex Fillset

- For cooling water systems up to 30°C only 50% of the nominal heating power should be considered when selecting the control unit
- In performance ranges > 2 MW we recommend using double pump systems

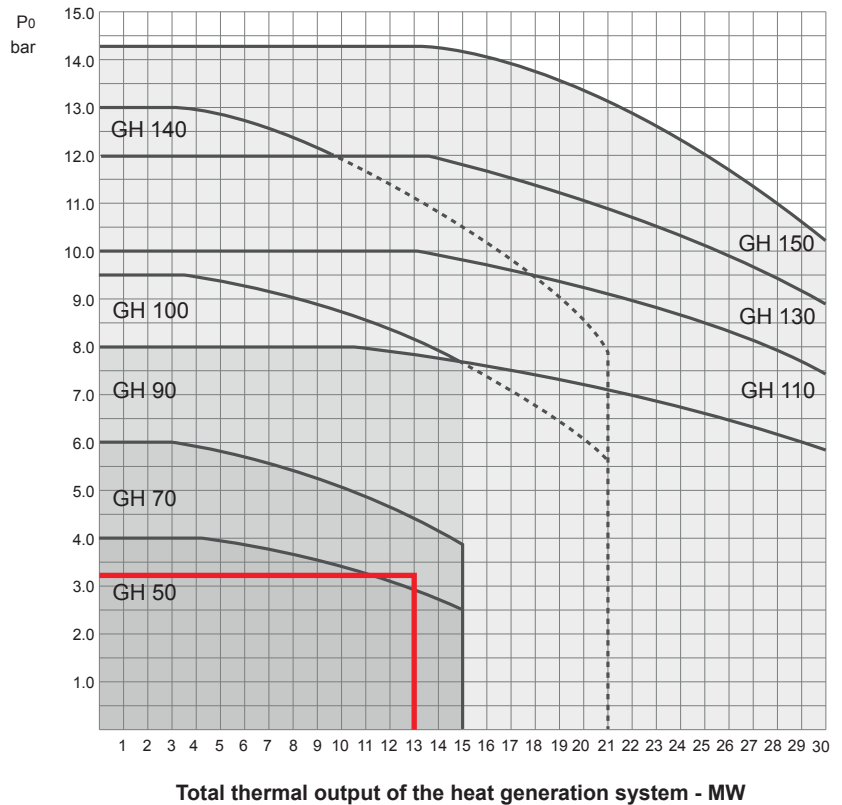

Variomat Giga GG - GF Vessel Sizing

- Nominal volume V_n

Approximate value from the diagram →

or

Calculation acc. to formula ↓

$$V_n \geq V_A \times \begin{matrix} 0.031 [70^\circ\text{C}] \\ 0.045 [90^\circ\text{C}] \\ 0.054 [100^\circ\text{C}] \\ 0.063 [110^\circ\text{C}] \end{matrix}$$

Setting flow temperature ↗

V_n = Nominal volume, liter

V_A = System water content, liter

- The nominal volumes can be distributed to several vessels (GG basic vessel and GF secondary vessel).

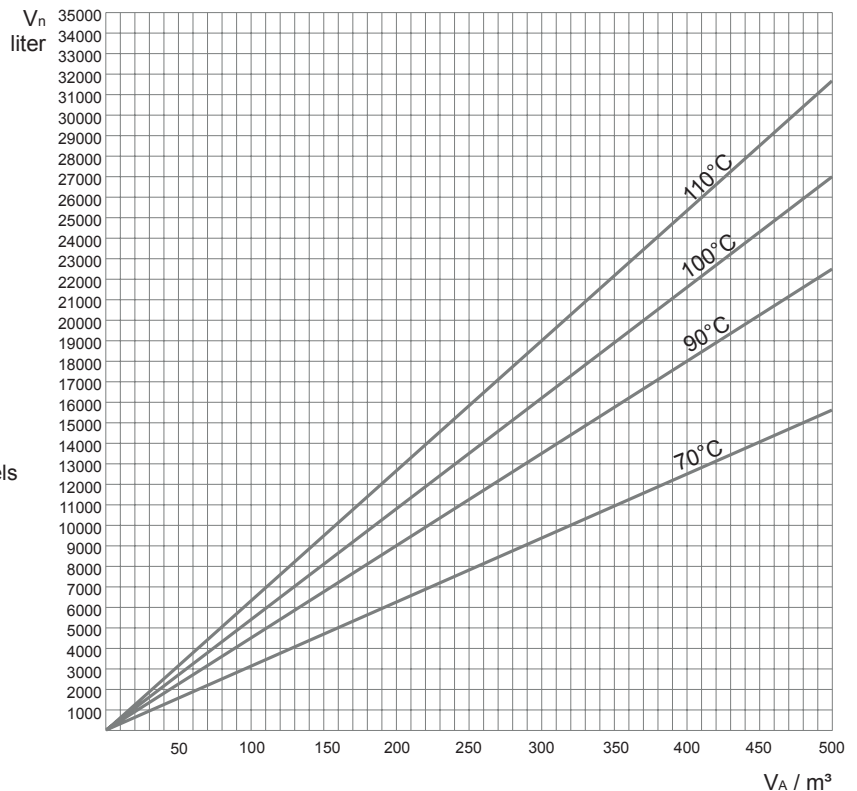

Notes

A series of horizontal dotted lines for writing notes.



The Reflex brand name is well known in Europe and throughout the world as a major leader in pressure control technology for heating, chilled and potable water applications. Our world wide growth has allowed us to build several state-of-the-art manufacturing facilities supplying the industry with outstanding quality products. Reflex Winkelmann GmbH having its headquarters in the Westfalian city of Ahlen is not only a recognized leader in expansion vessels but also a significant manufacturer of advanced system solutions such as compressor and pump-controlled pressurisation systems, automatic air separation systems and hot water heaters.



Reflex has achieved its significant global growth today thanks to the unique combination of its world-class manufacturing skills, dedication to high-product quality at an affordable price and its commitment to continuous technical training of its people, our most precious resource. Our tradition goes back to 1898. This family oriented company started its core business in the elaboration of steel. A business in which we are recognised leaders today. The Heinrich Winkelmann Group form the parent company to a whole group of diversified manufacturing companies serving the heating segment and the whole automotive industry with over 3.100 employees. A tradition of more than a hundred years in this business makes us real experts today.



Thinking solutions.

Reflex Winkelmann GmbH
Gersteinstrasse 19
59227 Ahlen, Germany

Phone: +49 2382 7069-0
Fax: +49 2382 7069-558

www.reflex.de